

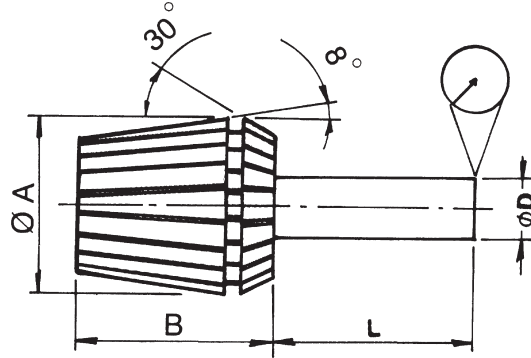

ER Spring Collet Chuck System

ER collet system of VERTEX is made of special elastic steel material under excellent heat treatment and precise grinding process, so it has precise accuracy, powerful clamping ability, and is durable. This collet can clamp for a specific standard size and its next size, (Refer to the data sheet on page 4). It can be widely used for boring, milling, drilling and tapping as well as for grinding operation, and is available for all sizes.

ER COLLET DIMENSIONS



TYPE	A	B
ER-8	8.5	13.5
ER-11	11.5	18
ER-16	17	27
ER-20	21	31
ER-25	26	35
ER-32	33	40
ER-40	41	46
ER-50	52	60

L m	D mm	DIN6343 Standard precision	VERTEX Standard precision	A Grade Optional
6	1.0-1.4	0.02	0.015	0.01
10	1.5-2.9	0.02	0.015	0.01
16	3.0-5.9	0.02	0.015	0.01
25	6.0-9.9	0.02	0.015	0.01
40	10.0-17.9	0.03	0.02	0.01
50	18.0-26.9	0.03	0.02	0.01
60	27.0-34.9	0.03	0.02	0.01

THE HIGH PRECISION OF A GRADE IS AVAILABLE

double-taper chuck

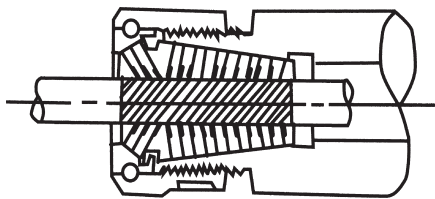

single-taper chuck

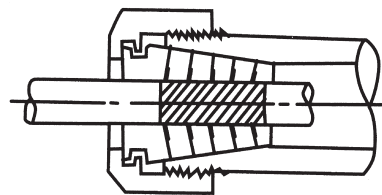

POWERFUL CLAMPING STRENGTH

The handle of the drill with double-taper chuck is longer than that with single-taper (grinding spring) collet. The clamping strength will be more powerful, if a screw-driver fastened by steel ball is adopted.

Mounting instructions for ER collets DIN 6499-A and DIN 6499-B

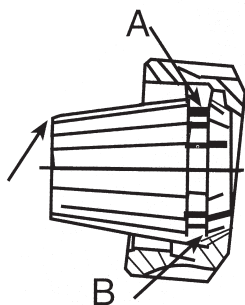

A- Place collet inside nut and rotate the nut to engage with the extractor spiral in colle groove.

B- Only then mount nut and collet together into the collet holder or machine spindle.

Note: Never use a 12-11mm collet to clamp a 12,2mm diameter, but rather use a 13-12mm collet.



ER Spring Collet Chuck System DIN 6499

STANDARD PRECISION TYPE



ER COLLET SET WITH CLAMPING RANGE

TYPE	ER-8		ER-11		ER-16		ER-20		ER-25		ER-32		ER-40		ER-50	
COMPLETE SET	9PCS/SET		7PCS/SET		10PCS/SET		12PCS/SET		15PCS/SET		18PCS/SET		23PCS/SET		12PCS/SET	
FULL SET	ORDER NO.	CAP. mm	ORDER NO.	CAP. mm	ORDER NO.	CAP. mm	ORDER NO.	CAP. mm	ORDER NO.	CAP. mm	ORDER NO.	CAP. mm	ORDER NO.	CAP. mm	ORDER NO.	CAP. mm
	CODE NO.	Ø	CODE NO.	Ø	CODE NO.	Ø	CODE NO.	Ø	CODE NO.	Ø	CODE NO.	Ø	CODE NO.	Ø	CODE NO.	Ø
	V08000 3001-101	0.5-5.0	V11000 3002-101	0.5-7.0	V16000 3003-101	0.5-10.0	V20000 3004-101	1-13	V25000 3005-101	1-16	V32000 3006-101	2-20	V40000 3007-101	3-26	V50000 3008-101	10-34
INDIVIDUAL UNIT	V08010 3001-001	1.0-0.5	V11010 3002-001	1.0-0.5	V16010 3003-001	1.0-0.5	V20020 3004-001	2-1	V25020 3005-001	2-1	V32030 3006-001	3-2	V40040 3007-001	4-3	V50120 3008-001	12-10
	V08015 3001-002	1.5-1.0	V11020 3002-002	2.0-1.5	V16020 3003-002	2.0-1.0	V20030 3004-002	3-2	V25030 3005-002	3-2	V32040 3006-002	4-3	V40050 3007-002	5-4	V50140 3008-002	14-12
	V08020 3001-003	2.0-1.5	V11030 3002-003	3.0-2.5	V16030 3003-003	3.0-2.0	V20040 3004-003	4-3	V25040 3005-003	4-3	V32050 3006-003	5-4	V40060 3007-003	6-5	V50160 3008-003	16-14
	V08025 3001-004	2.5-2.0	V11040 3002-004	4.0-3.5	V16040 3003-004	4.0-3.0	V20050 3004-004	5-4	V25050 3005-004	5-4	V32060 3006-004	6-5	V40070 3007-004	7-6	V50180 3008-004	18-16
	V08030 3001-005	3.0-2.5	V11050 3002-005	5.0-4.5	V16050 3003-005	5.0-4.0	V20060 3004-005	6-5	V25060 3005-005	6-5	V32070 3006-005	7-6	V40080 3007-005	8-7	V50200 3008-005	20-18
	V08035 3001-006	3.5-3.0	V11060 3002-006	6.0-5.5	V16060 3003-006	6.0-5.0	V20070 3004-006	7-6	V25070 3005-006	7-6	V32080 3006-006	8-7	V40090 3007-006	9-8	V50220 3008-006	22-20
	V08040 3001-007	4.0-3.5	V11070 3002-007	7.0-6.5	V16070 3003-007	7.0-6.0	V20080 3004-007	8-7	V25080 3005-007	8-7	V32090 3006-007	9-8	V40100 3007-007	10-9	V50240 3008-007	24-22
	V08045 3001-008	4.5-4.0	V11015 3002-008	1.5	V16080 3003-008	8.0-7.0	V20090 3004-008	9-8	V25090 3005-008	9-8	V32100 3006-008	10-9	V40110 3007-008	11-10	V50260 3008-008	26-24
	V08050 3001-009	5.0-4.5	V11025 3002-009	2.5	V16090 3003-009	9.0-8.0	V20100 3004-009	10-9	V25100 3005-009	10-9	V32110 3006-009	11-10	V40120 3007-009	12-11	V50280 3008-009	28-26
			V11035 3002-010	3.5	V16100 3003-010	10.0-9.0	V20110 3004-010	11-10	V25110 3005-010	11-10	V32120 3006-010	12-11	V40130 3007-010	13-12	V50300 3008-010	30-28
			V11045 3002-011	4.5	V16015 3003-011	1.5	V20120 3004-011	12-11	V25120 3005-011	12-11	V32130 3006-011	13-12	V40140 3007-011	14-13	V50320 3008-011	32-30
			V11055 3002-012	5.5	V16025 3003-012	2.5	V20130 3004-012	13-12	V25130 3005-012	13-12	V32140 3006-012	14-13	V40150 3007-012	15-14	V50340 3008-012	34-32
			V11065 3002-013	6.5	V16035 3003-013	3.5	V20010 3004-013	1.0	V25140 3005-013	14-13	V32150 3006-013	15-14	V40160 3007-013	16-15		
					V16045 3003-014	4.5	V20025 3004-014	2.5	V25150 3005-014	15-14	V32160 3006-014	16-15	V40170 3007-014	17-16		
					V16055 3003-015	5.5	V20035 3004-015	3.5	V25160 3005-015	16-15	V32170 3006-015	17-16	V40180 3007-015	18-17		
					V16065 3003-016	6.5	V20045 3004-016	4.5			V32180 3006-016	18-17	V40190 3007-016	19-18		
					V16075 3003-017	7.5	V20055 3004-017	5.5			V32190 3006-017	19-18	V40200 3007-017	20-19		
					V16085 3003-018	8.5	V20065 3004-018	6.5			V32200 3006-018	20-19	V40210 3007-018	21-20		
					V16095 3003-019	9.5	V20075 3004-019	7.5					V40220 3007-019	22-21		
							V20085 3004-020	8.5					V40230 3007-020	23-22		
						V20095 3004-021	9.5					V40240 3007-021	24-23			
						V20105 3004-022	10.5					V40250 3007-022	25-24			
						V20115 3004-023	11.5					V40260 3007-023	26-25			
						V20125 3004-024	12.5									
						V20135 3004-025	13.5									
		Note:														
		APPROXIMATE WEIGHT														
		FOR EACH (kgs)														
		ER-8	0.001													
		ER-11	0.02													
		ER-16	0.04													
		ER-20	0.05													
		ER-25	0.07													
		ER-32	0.15													
		ER-40	0.28													
		ER-50	0.54													



ER Spring Collet Chuck System

SUPER ULTRA PRECISION TYPE

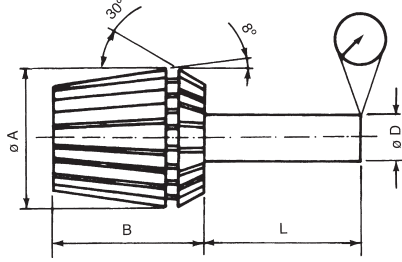

Dimension

Type	D	H
ER08	8.5	13.5
ER11	11.5	18
ER16	17	27
ER20	21	31
ER25	26	35
ER32	33	40
ER40	41	46
ER50	52	60

Accuracy

L(MM)	øD(MM)	Ultra Precision(MM)
6	1.0-1.4	0.01
10	1.5-2.9	0.01
16	3.0-5.9	0.01
25	6.0-9.9	0.01
40	10.0-17.9	0.01
50	18.0-26.9	0.01
60	27.0-34.9	0.01

TYPE	ER-8		ER-11		ER-16		ER-20		ER-25		ER-32		ER-40		ER-50	
COMPLETE SET	9PCS/SET		7PCS/SET		10PCS/SET		12PCS/SET		15PCS/SET		18PCS/SET		23PCS/SET		12PCS/SET	
FULL SET	ORDER NO.	CAP. mm	ORDER NO.	CAP. mm	ORDER NO.	CAP. mm	ORDER NO.	CAP. mm	ORDER NO.	CAP. mm	ORDER NO.	CAP. mm	ORDER NO.	CAP. mm	ORDER NO.	CAP. mm
	CODE NO.	Ø	CODE NO.	Ø	CODE NO.	Ø	CODE NO.	Ø	CODE NO.	Ø	CODE NO.	Ø	CODE NO.	Ø	CODE NO.	Ø
INDIVIDUAL UNIT	V08000S 3000-001	0.5-5.0	V11000S 3000-002	0.5-7.0	V16000S 3000-003	0.5-10.0	V20000S 3000-004	1-13	V25000S 3000-005	1-16	V32000S 3000-006	2-20	V40000S 3000-007	3-26	V50000S 3000-008	10-34
	V08010S 3000-010	1.0-0.5	V11010S 3000-020	1.0-0.5	V16010S 3000-040	1.0-0.5	V20020S 3000-060	2-1	V25020S 3000-090	2-1	V32030S 3000-110	3-2	V40040S 3000-130	4-3	V50120S 3000-160	12-10
	V08015S 3000-011	1.5-1.0	V11020S 3000-021	2.0-1.5	V16020S 3000-041	2.0-1.0	V20030S 3000-061	3-2	V25030S 3000-091	3-2	V32040S 3000-111	4-3	V40050S 3000-131	5-4	V50140S 3000-161	14-12
	V08020S 3000-012	2.0-1.5	V11030S 3000-022	3.0-2.5	V16030S 3000-042	3.0-2.0	V20040S 3000-062	4-3	V25040S 3000-092	4-3	V32050S 3000-112	5-4	V40060S 3000-132	6-5	V50160S 3000-162	16-14
	V08025S 3000-013	2.5-2.0	V11040S 3000-023	4.0-3.5	V16040S 3000-043	4.0-3.0	V20050S 3000-063	5-4	V25050S 3000-093	5-4	V32060S 3000-113	6-5	V40070S 3000-133	7-6	V50180S 3000-163	18-16
	V08030S 3000-014	3.0-2.5	V11050S 3000-024	5.0-4.5	V16050S 3000-044	5.0-4.0	V20060S 3000-064	6-5	V25060S 3000-094	6-5	V32070S 3000-114	7-6	V40080S 3000-134	8-7	V50200S 3000-164	20-18
	V08035S 3000-015	3.5-3.0	V11060S 3000-025	6.0-5.5	V16060S 3000-045	6.0-5.0	V20070S 3000-065	7-6	V25070S 3000-095	7-6	V32080S 3000-115	8-7	V40090S 3000-135	9-8	V50220S 3000-165	22-20
	V08040S 3000-016	4.0-3.5	V11070S 3000-026	7.0-6.5	V16070S 3000-046	7.0-6.0	V20080S 3000-066	8-7	V25080S 3000-096	8-7	V32090S 3000-116	9-8	V40100S 3000-136	10-9	V50240S 3000-166	24-22
	V08045S 3000-017	4.5-4.0	V11015S 3000-027	1.5	V16080S 3000-047	8.0-7.0	V20090S 3000-067	9-8	V25090S 3000-097	9-8	V32100S 3000-117	10-9	V40110S 3000-137	11-10	V50260S 3000-167	26-24
	V08050S 3000-018	5.0-4.5	V11025S 3000-028	2.5	V16090S 3000-048	9.0-8.0	V20100S 3000-068	10-9	V25100S 3000-098	10-9	V32110S 3000-118	11-10	V40120S 3000-138	12-11	V50280S 3000-168	28-26
			V11035S 3000-029	3.5	V16100S 3000-049	10.0-9.0	V20110S 3000-069	11-10	V25110S 3000-099	11-10	V32120S 3000-119	12-11	V40130S 3000-139	13-12	V50300S 3000-169	30-28
			V11045S 3000-030	4.5	V16015S 3000-050	1.5	V20120S 3000-070	12-11	V25120S 3000-100	12-11	V32130S 3000-120	13-12	V40140S 3000-140	14-13	V50320S 3000-170	32-30
			V11055S 3000-031	5.5	V16025S 3000-051	2.5	V20130S 3000-071	13-12	V25130S 3000-101	13-12	V32140S 3000-121	14-13	V40150S 3000-141	15-14	V50340S 3000-171	34-32
			V11065S 3000-032	6.5	V16035S 3000-052	3.5	V20010S 3000-072	1.0	V25140S 3000-102	14-13	V32150S 3000-122	15-14	V40160S 3000-142	16-15		
					V16045S 3000-053	4.5	V20025S 3000-073	2.5	V25150S 3000-103	15-14	V32160S 3000-123	16-15	V40170S 3000-143	17-16		
					V16055S 3000-054	5.5	V20035S 3000-074	3.5	V25160S 3000-104	16-15	V32170S 3000-124	17-16	V40180S 3000-144	18-17		
					V16065S 3000-055	6.5	V20045S 3000-075	4.5			V32180S 3000-125	18-17	V40190S 3000-145	19-18		
					V16075S 3000-056	7.5	V20055S 3000-076	5.5			V32190S 3000-126	19-18	V40200S 3000-146	20-19		
				V16085S 3000-057	8.5	V20065S 3000-077	6.5			V32200S 3000-127	20-19	V40210S 3000-147	21-20			
				V16095S 3000-058	9.5	V20075S 3000-078	7.5					V40220S 3000-148	22-21			
						V20085S 3000-079	8.5					V40230S 3000-149	23-22			
						V20095S 3000-080	9.5					V40240S 3000-150	24-23			
						V20105S 3000-081	10.5					V40250S 3000-151	25-24			
						V20115S 3000-082	11.5					V40260S 3000-152	26-25			
						V20125S 3000-083	12.5									



ER Spring Collet Chuck System DIN 6499

ER COLLET SET

STANDARD PRECISION TYPE



ER-50



ER-40



ER-32



ER-25



ER-20



ER-16



ER-11



ER-8

COLLET KITS

	PE	COLLET SIZE INSIDE DIA.	PCS/SET	KGS/PACKING	CODE NO.
V-08000	ER-8	1+0.5-5mm(1,1.5,2,2.5,3,3.5,4,4.5,5mm)	9PCS	0.8(C)	3001-101
V-11000	ER-11	1-7mm(1,2,3,4,5,6,7mm)	7PCS	0.3(C)	3002-101
V-11013		1+0.5-7mm(1,1.5,2,2.5,3,3.5,4,4.5,5,5.5,6,6.5,7mm)	13PCS	0.3(C)	3002-102
V-16000	ER-16	1-10mm(1,2,3,4,5,6,7,8,9,10mm)	10PCS	0.7(C)	3003-101
V-16008		3-10mm(3,4,5,6,7,8,9,10mm)	8PCS	0.6(C)	3003-102
V-20000	ER-20	2-13mm(2,3,4,5,6,7,8,9,10,11,12,13mm)	12PCS	0.9(C)	3004-101
V-20008		4-13mm(4,5,6,7,8,9,10,11,1,2,13mm)	10PCS	0.8(C)	3004-102
V-25000	ER-25	2-16mm(2,3,4,5,6,7,8,9,10,11,12,13,14,15,16mm)	15PCS	1.3(W)	3005-101
V-25008		4-16mm(4,5,6,7,8,9,10,11,12,13,14,15,16mm)	13PCS	1.0(W)	3005-102
V-25009		6,8,10,12,16mm	5PCS	0.4(C)	3005-103
V-25010		4,6,8,10,12,14,16mm	7PCS	0.35(C)	3005-104
V-32000	ER-32	3-20mm(3,4,5,6,7,8,9,10,11,12,13,14,15,16,17,18,19,20mm)	18PCS	3.3(P)	3006-101
V-32008		4,5,6,8,10,12,13,15,16,18,20mm	11PCS	2.8(P)	3006-102
V-32009		6,8,10,12,16,20mm	6PCS	0.9(P)	3006-103
V-40000	ER-40	4-26mm(4,5,6,7,8,9,10,11,12,13,14,15,16,17,18,19,20,21,22,23,24,25,26mm)	23PCS	6.5(P)	3007-101
V-40008		4,5,6,8,10,12,13,15,16,18,20,21,22,25,26mm	15PCS	4.2(P)	3007-102
V-40009		6,8,10,12,16,20,25mm	7PCS	2.0(P)	3007-103
V-50000	ER-50	12,14,16,18,20,22,24,26,28,30,32,34mm	12PCS	6.5(W)	3008-101





ER Spring Collet Chuck System

Collet Chuck Kit With ISO Taper Shank

DIN 2080/ISO SHANK
DIN 6499

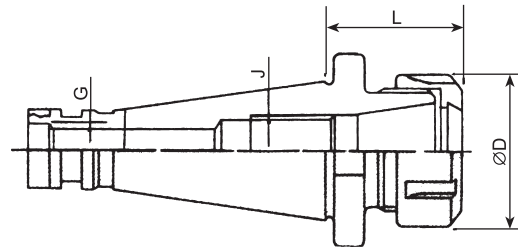

ORDER NO.	TAPER	COLLET TYPE	L	D	G	WEIGHT KG.	CODE NO.
V-101	NT30	ER32	55	50	1/2"-12W,M12X1.75P (USA 1/2"-UNC13)	0.6	3020-301
V-102		ER40	70	63		1	3020-302
V-103	NT40	ER32	50	60	5/8"-11W or M16X2.0P	1	3021-301
V-104		ER40	60	63		1.3	3021-302
V-105		ER50	80	78		1.9	3021-303
V-106	NT50	ER32	60	50	1"-8W or M24X3.0P	2.6	3022-301
V-107		ER40	65	63		3.2	3022-302
V-108		ER50	65	78		3.5	3022-303
※ V-109	NT30	ER25	55	42	1/2"-12W,M12X1.75P	0.55	3020-303
※ V-110	NT40	ER25	50	42	5/8"-11W,M16X2.0P	1.0	3021-304

Collet Chuck Kit With ISO Taper Shank

Including shank, full set of collets, wrench and case.



Please notify the taper size, collet type, set range, and set numbers when ordering.

ORDER NO.	TAPER	COLLET TYPE	SET RANGE	SET PCS	WEIGHT KG.	
V-201	NT30	ER32	3-20	18	4.2	3020-401
V-202			4-20	11	3.2	3020-402
V-203			6-20	6	2.8	3020-403
V-204	NT30	ER40	4-26	23	7.3	3020-404
V-205			4-26	15	6	3020-405
V-206			6-25	7	4.6	3020-406
V-207	NT40	ER32	3-20	18	4.8	3021-401
V-208			4-20	11	3.8	3021-402
V-209			6-20	6	3.4	3021-403
V-210	NT40	ER40	4-26	23	8.2	3021-404
V-211			4-26	15	6.9	3021-405
V-212			6-25	7	5.2	3021-406
V-213	NT40	ER50	12-34	12	10	3021-407
V-214	NT50	ER32	3-20	18	6.4	3022-401
V-215			4-20	11	5.4	3022-402
V-216			6-20	6	5.5	3022-403
V-217	NT50	ER40	4-26	23	9.8	3022-404
V-218			4-26	15	8.5	3022-405
V-219			6-25	7	7	3022-406
V-220	NT50	ER50	12-34	12	11	3022-407
※ V-223	NT30	ER25	2-16	7	2.8	3020-407
※ V-224			4-16	15	2.4	3020-408
※ V-225	NT40	ER25	2-16	7	3.3	3021-409
※ V-226			4-16	15	3.0	3021-410



ER Spring Collet Chuck System DIN 6499

Extended Collet Holder With ISO Shank

DIN 2080/ISO SHANK EXTENDED CHUCK

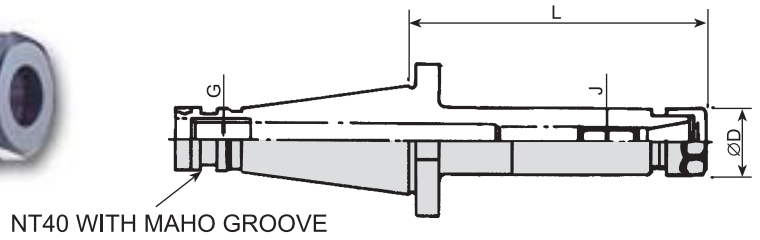

ORDER NO.	TAPER	COLLET TYPE	L	D	G	WEIGHT KG.	CODE NO.
V-231	NT30	ER16	76	28	1/2"-12W,M12X1.75 USA 1/2"-UNC13	0.6	3020-304
V-231A		ER20		34			3020-305
V-232	NT40	ER16	76	28	5/8"-11W or M16X2.0P	1	3021-314
V-233		ER16	100	28		1.2	3021-305
V-234		ER20	76	34		1	3021-306
V-235		ER20	100	34		1.2	3021-307
V-236	NT50	ER16	100	28	1"-8W or M24X3.0P	3.2	3022-304
V-237		ER16	150	28		3.6	3022-305
V-238		ER20	100	34		3.4	3022-306
V-239		ER20	150	34		3.8	3022-307

Extended Collet Chuck Kit With ISO Shank

Including shank, full set of collets, wrench and case.



Please notify the taper size, collet type, set range, and set numbers when ordering.

ORDER NO.	TAPER	COLLET TYPE	RANGE	PCS/SET	L	WEIGHT KG.	CODE NO.
V-241	NT30	ER16	1-10	10	76	1.9	3020-409
V-242			3-10	8		1.8	3020-410
V-242A		ER20	2-13	12		1.8	3020-411
V-243	NT40	ER16	1-10	10	76	2.2	3021-411
V-244			3-10	8		2.1	3021-412
V-245		ER16	1-10	10	100	2.4	3021-413
V-246			3-10	8		2.3	3021-414
V-247		ER20	2-13	12	76	2.3	3021-415
V-248			4-13	10		2.2	3021-416
V-249	ER20	2-13	12	100	2.6	3021-417	
V-250			4-13		10	2.5	3021-418
V-251		NT50	ER16	1-10	10	100	4.2
V-252	3-10			8	4.1		3022-409
V-253	ER16		1-10	10	160	4.6	3022-410
V-254			3-10	8		4.5	3022-411
V-255	ER20		2-13	12	100	4.3	3022-412
V-256			4-13	10		4.2	3022-413
V-257	ER20		2-13	12	160	4.7	3022-414
V-258				4-13		10	4.6



ER Spring Collet Chuck System R-8 SHANK

Collet Holders With R-8 shank

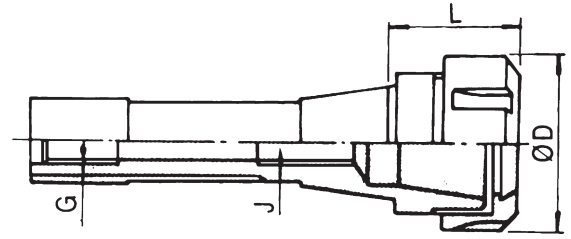

ORDER NO.	TAPER	COLLET TYPE	L	D	G	WEIGHT KG.	CODE NO.
V-301	R8	ER16	38	28	7/16"X20 UNF	0.3	3027-301
V-302		ER32	40	50		0.6	3027-302
V-303		ER40	70	63		1	3027-303

Collet Chuck Kit With R-8 Shank

Including shank, full set of collets, wrench and case. (ER16 No Wrench)



Please notify the taper size, collet type, set range, and set numbers when ordering.

ORDER NO.	TAPER	COLLET TYPE	SET RANGE	SET PCS	WEIGHT KG.	
V-311	R8	ER16	1-10	10	1.5(W)	3027-401
V-312		ER16	3-10	8	1.45(P)	3027-402
V-313	R8	ER32	3-20	18	4.3(P)	3027-403
V-314		ER32	4-20	11	3.2(P)	3027-404
V-315		ER32	6-20	6	2.9(P)	3027-405
V-316	R8	ER40	4-26	23	7.3(P)	3027-406
V-317		ER40	4-26	15	6.1(P)	3027-407
V-318		ER40	6-25	7	4.6(P)	3027-408



ER Spring Collet Chuck System

MT-SHANK

Collet Holders With Morse Taper Shank

DIN 6499
DIN 228

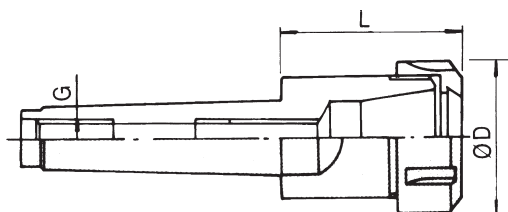

ORDER NO.	TAPER	COLLET TYPE	L	D	G	WEIGHT KG.	CODE NO.	
V-401	MT2	ER16	40	28	3/8"-16W or M10 X 1.5P	0.3	3023-301	
V-402		ER20	43	34		0.3	3023-302	
V-403		ER25	47	42		0.4	3023-303	
V-404	MT3	ER16	40	28	3/8"-16W or 1/2"-12W M10X1.5P.M12X1.75P USA 1/2"-UNC13	0.4	3024-301	
V-405		ER32	70	50		0.55	3024-302	
V-406		ER40	80	63		0.85	3024-303	
V-451		ER20	43	34		1/2"-12NC M12 X 1.75P	0.3	3024-304
V-452		ER25	47	42		0.4	3024-305	
V-407	MT4	ER32	60	50	5/8"-11W or M16 X 2.0P	0.6	3025-301	
V-408		ER40	82	63		1	3025-302	
V-409		ER50	85	78		1.8	3025-303	
V-410	MT5	ER40	82	63	1"-8W or M24 X 3.0P	1.8	3026-301	
V-411		ER50	85	78		2.5	3026-302	

NEW

Collet Chuck Kit With Morse Taper Shank

Including shank, full set of collets, wrench and case. (ER16, ER20 no Wrench)

- 1.ER16, 20, 25, PACKED IN WOODEN BOX (W)
- 2.ER32, 40, 50, PACKED IN PLASTIC BOX (P)



Please notify the taper size, collet type, set range, and set numbers when ordering.

ORDER NO.	TAPER	COLLET TYPE	SET RANGE	SET PCS	WEIGHT KG.	CODE NO.	
V- 412	MT2	ER16	1-10	10	1.05	3023-401	
V- 413		ER16	3-10	8	1	3023-402	
V- 414		ER20	2-13	12	1.3	3023-403	
V- 415		ER20	4-13	10	1.2	3023-404	
V- 416		ER25	2-16	15	2.4	3023-405	
V- 418	MT3	ER25	4-16	7	1.3	3023-407	
V- 419		ER16	1-10	10	1.5	3024-401	
V- 420		ER16	3-10	8	1.1	3024-402	
V- 441		ER20	2-13	12	1.35	3023-408	
V- 442		ER20	4-13	10	1.3	3023-409	
V- 443		ER25	2-16	15	2.5	3023-410	
V- 444		ER25	4-16	7	2.1	3023-411	
V- 421		ER32	3-20	18	4.1	3024-403	
V- 422		ER32	4-20	11	3	3024-404	
V- 423		ER32	6-20	6	2.7	3024-405	
V- 424		ER40	4-26	23	7.2	3024-406	
V- 425		ER40	4-26	15	6	3024-407	
V- 426		ER40	6-25	7	4.5	3024-408	
V- 427		MT4	ER32	3-20	18	4.3	3025-401
V- 428			ER32	4-20	11	3.2	3025-402
V- 429	ER32		6-20	6	2.9	3025-403	
V- 430	ER40		4-26	23	7.3	3025-404	
V- 431	ER40		4-26	15	6.1	3025-405	
V- 432	ER40		6-25	7	4.6	3025-406	
V- 433	ER50		12-34	12	9	3025-407	
V- 434	MT5	ER40	4-26	23	8.2	3026-401	
V- 435		ER40	4-26	15	6.9	3026-402	
V- 436		ER40	6-25	7	5.4	3026-403	
V- 437		ER50	12-34	12	9.5	3026-404	

NEW



ER Spring Collet Chuck System

DIN6499
STRAIGHT SHANK

Collet Holders With Straight Shank

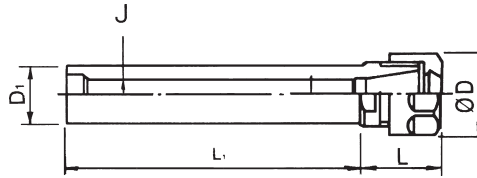

ORDER NO.	COLLET TYPE	SHANK D1XL1	L	D	J	KGS	CODE NO.
V-530	ER11	Ø16X50	21	19	M10	0.15	3007-300
V-531		Ø16X100	21	19	M10	0.15	3007-311
V-532		Ø16X150	21	19	M10	0.25	3007-312
V-501	ER16	Ø20X50	30	28	M12	0.18	3003-301
V-502		Ø20X100	30	28	M12	0.25	3003-302
V-503		Ø20X150	30	28	M12	0.35	3003-303
V-504		Ø25X100	30	28	M12	0.35	3003-304
V-504A		Ø25X50	30	28	M12	0.25	3003-306
V-505		Ø25X150	30	28	M12	0.45	3003-305
V-505A		Ø25X200	30	28	M12	0.5	3003-307
V-506	ER20	Ø20X50	36	34	M12	0.18	3004-301
V-507		Ø20X100	36	34	M12	0.25	3004-302
V-508		Ø20X150	36	34	M12	0.35	3004-303
V-509		Ø25X150	36	34	M12	0.45	3004-304
V-509A		Ø25X100	36	34	M12	0.45	3004-305
V-509B		Ø25X50	36	34	M12	0.35	3004-306
V-510	ER25	Ø20X50	46	42	M12	0.35	3005-301
V-511		Ø20X100	46	42	M12	0.4	3005-302
V-512		Ø20X150	46	42	M12	0.5	3005-303
V-513		Ø25X100	46	42	M12	0.5	3005-304
V-514		Ø25X150	46	42	M12	0.6	3005-305
V-515		Ø32X60	46	50	M12	0.5	3005-306
V-516	ER32	Ø25X80	54	50	M16	0.5	3006-301
V-517		Ø32X100	54	50	M16	0.6	3006-302
V-517A		Ø32X150	54	50	M16	0.85	3006-305
V-518		Ø40X100	54	50	M16	0.8	3006-303
V-523	ER40	Ø32X100	55	63	M16	1.0	3007-302
V-524		Ø40X100	55	63	M16	1.3	3007-303



ER Spring Collet Chuck System

DIN6499
STRAIGHT SHANK



Collet Chuck Kit With Straight Shank

Including shank, full set of collets, wrench and case.

(ER16, ER20 no Wrench)

COLLET CHUCK SETS

ORDER NO.	SHANK D1XL1	COLLET TYPE	SET RANGE	SET PCS	KGS.	CODE NO.
V-681	Ø 16X50L	ER11	1-7	13	0.6	3002-401
V-682	Ø 16X50L		1-7	7	0.5	3002-402
V-683	Ø 16X100L		1-7	13	0.7	3002-403
V-684	Ø 16X100L		1-7	7	0.6	3002-404

ORDER NO.	SHANK D1XL1	COLLET TYPE	SET RANGE	SET PCS	KGS.	CODE NO.
V-601	Ø20X50L	ER16	1-10	10	1.1	3003-401
V-602	Ø20X50L		3-10	8	1.05	3003-402
V-603	Ø20X100L		1-10	10	1.2	3003-403
V-604	Ø20X100L		3-10	8	1.15	3003-404
V-605	Ø20X150L		1-10	10	1.1	3003-405
V-606	Ø20X150L		3-10	8	1.05	3003-406
V-607	Ø25X100L		1-10	10	1.2	3003-407
V-607A	Ø25X50L		1-10	10	1.1	3003-411
V-608	Ø25X100L		3-10	8	1.15	3003-408
V-608A	Ø25X50L		3-10	8	1.05	3003-412
V-609	Ø25X150L	1-10	10	1.35	3003-409	
V-610	Ø25X150L	3-10	8	1.3	3003-410	
V-611	Ø20X50L	ER20	2-13	12	1.2	3004-401
V-612	Ø20X50L		4-13	10	1.15	3004-402
V-613	Ø20X100L		2-13	12	1.3	3004-403
V-614	Ø20X100L		4-13	10	1.25	3004-404
V-615	Ø20X150L		2-13	12	1.4	3004-405
V-615A	Ø25X50L		2-13	12	1.3	3004-409
V-616	Ø20X150L		4-13	10	1.35	3004-406
V-616A	Ø25X50L		4-13	10	1.25	3004-410
V-617	Ø25X100L		2-13	12	1.4	3004-407
V-617A	Ø25X150L		2-13	12	1.5	3004-411
V-618	Ø25X100L		4-13	10	1.35	3004-408
V-618A	Ø25X150L		4-13	10	1.45	3004-412
V-619	Ø20X50L		2-16	15	2.4	3005-401
V-621	Ø20X50L		6-16	7	1.7	3005-403
V-622	Ø20X100L		2-16	15	2.4	3005-404
V-624	Ø20X100L		6-16	7	1.8	3005-406
V-625	Ø20X150L		2-16	15	2.5	3005-407
V-627	Ø20X150L		6-16	7	1.9	3005-409
V-628	Ø25X100L	2-16	15	2.5	3005-410	

ORDER NO.	SHANK D1XL1	COLLET TYPE	SET RANGE	SET PCS	KGS.	CODE NO.
V-630	Ø25X100L	ER25	6-16	7	1.9	3005-412
V-631	Ø25X150L		2-16	15	2.65	3005-413
V-633	Ø25X150L		6-16	7	2.0	3005-415
V-634	Ø32X60L		2-16	15	2.5	3005-416
V-636	Ø32X60L		6-16	7	2.0	3005-418
V-637	Ø25X80L		ER32	3-20	18	4.1
V-638	Ø25X80L	4-20		11	3	3006-402
V-639	Ø25X80L	3-20		6	2.7	3006-403
V-640	Ø32X100L	4-20		18	4.3	3006-404
V-641	Ø32X100L	6-20		11	3.2	3006-405
V-642	Ø32X100L	6-20		6	2.9	3006-406
V-643	Ø40X100L	3-20		18	4.6	3006-407
V-644	Ø40X100L	4-20		11	3.5	3006-408
V-645	Ø40X100L	6-20		6	3.2	3006-409
V-646	Ø1"XL3	3-20		18	4.1	3006-410
V-647	Ø1"XL3	4-20		11	3	3006-411
V-648	Ø1"XL3	6-20		6	2.9	3006-412
V-658	Ø32X100L	ER40	4-26	23	7.3	3007-404
V-659	Ø32X100L		4-26	15	6.1	3007-405
V-660	Ø32X100L		6-25	7	4.6	3007-406
V-661	Ø40X100L		4-26	23	7.6	3007-407
V-662	Ø40X100L		4-26	15	6.5	3007-408
V-663	Ø40X100L		6-25	7	5	3007-409

- V-603, V-604 are the most popular item.
- THE ER-20/25/32/40 ARE TO BE CONTINUED
- V-613, V-614 are the most popular item.



ER Spring Collet Chuck System DIN6499 MINI STRAIGHT SHANK

MINI TYPE
STRAIGHT SHANK HOLDER



COLLET HOLDER (MINI TYPE)

ORDER NO.	COLLET TYPE	SHANK D1XL1	D	L	KGS	CODE NO.
V-551	ER11M	ST16X50L	16	22	0.15	3011-301
V-552		ST16X100L	16	22	0.2	3011-302
V-552A		ST16X150L	16	22	0.25	3011-303
V-553	ER16M	ST20X50L	22	32	0.18	3012-301
V-554		ST20X100L	22	32	0.25	3012-302
V-555		ST20X150L	22	32	0.35	3012-303
V-555A		ST20X200L	22	32	0.4	3012-307
V-556	ER20M	ST20X50L	28	33	0.2	3013-301
V-557		ST20X100L	28	33	0.28	3013-302
V-558		ST20X150L	28	33	0.35	3013-303
V-559		ST25X100L	28	33	0.35	3013-304
V-560		ST25X150L	28	33	0.4	3013-305
V-561	ER16M	ST16X100L	32	22	0.18	3012-304
V-562		ST25X100L	32	22	0.35	3012-305
V-563		ST25X150L	32	22	0.4	3012-306
V-563A		ST25X200L	22	32	0.45	3012-308
V-557A	ER20M	ST20X200L	28	35	0.4	3013-306
V-560A		ST25X200L	28	35	0.45	3013-307



MINI TYPE

**Collet Holders Kit
With Straight Shank**
Including shank,
full set of collets,
wrench and case.

MINI TYPE

ORDER NO.	SHANK D1XL1	COLLET TYPE	SET RANGE	SET PCS	KGS	CODE NO.
V-691A	ST16X50L	ER11M	1-7	7	0.5	3011-401
V-691B	ST16X50L		1-7	13	0.6	3011-402
V-692A	ST16X100L		1-7	7	0.6	3011-403
V-692B	ST16X100L		1-7	13	0.7	3011-404
V-693A	ST20X50L	ER16M	1-10	10	1.05	3012-401
V-693B	ST20X50L		3-10	8	1.0	3012-402
V-693C	ST16X100L		1-10	10	1	3012-407
V-694A	ST20X100L		1-10	10	1.15	3012-403
V-694B	ST20X100L		3-10	8	1.1	3012-404
V-695A	ST20X150L		1-10	10	1.3	3012-405
V-695B	ST20X150L		3-10	8	1.2	3012-406
V-695C	ST25X100L		1-10	10	1.2	3012-408
V-695D	ST25X100L	1-10	10	1.35	3012-409	
V-696A	ST20X50L	ER20M	2-13	12	1.3	3013-401
V-696B	ST20X50L		4-13	10	1.2	3013-402
V-697A	ST20X100L		2-13	12	1.4	3013-403
V-697B	ST20X100L		4-13	10	1.3	3013-404
V-698A	ST20X150L		2-13	12	1.5	3013-405
V-698B	ST20X150L		4-13	10	1.4	3013-406
V-698C	ST25X100L		2-13	12	1.4	3013-407
V-698D	ST25X150L		2-13	12	1.5	3013-408



Clamping Nuts & Wrench For Collets

DIN 6499

ER CLAMPING NUT SYSTEM

CLAMPING NUTS



RDER	Fig.	COLLET TYPE	D	H	G		CODE NO.
V-800	3	ER11UM	19	13	M14X0.75P	0.01	3015-001
V-801	3	ER16UM	28	18	M22X1.5P	0.035	3015-002
V-802	3	ER20UM	34	21	M25X1.5P	0.06	3015-003
V-803	4	ER25UM	42	20	M32X1.5P	0.095	3015-004
V-804	4	ER32UM	50	23	M40X1.5P	0.15	3015-005
V-805	4	ER40UM	63	25	M50X1.5P	0.31	3015-006
V-806	4	ER50UM	78	35	M64X2.0P	0.58	3015-007
V-807	1	ER11MS	16	12	M13X0.75P	0.01	3015-008
V-808	2	ER16M	22	18	M19X1.0P	0.035	3015-009
V-809	2	ER20M	28	19	M24X1.0P	0.06	3015-010
V-810A	5	ER40KM	63	29	M50X1.5P	0.31	3015-011
V-810B	5	ER50KM	78	40	M64X2.0P	0.58	3015-012
V-810C	2	ER-11M	16	12	M13X0.75P	0.01	3015-013
V810D		ER-8M	12	10.8	M10X0.75P	0.01	3015-014

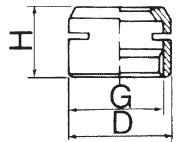

Fig.1 ER11MS

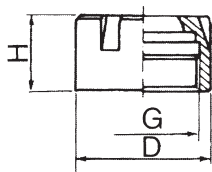

Fig.2 ER11,16,20M

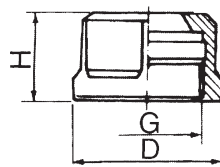

Fig.3 ER11,16,20UM

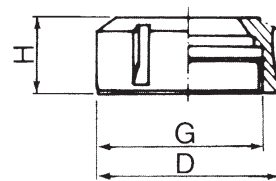

Fig.4 ER25,32,40,50UM

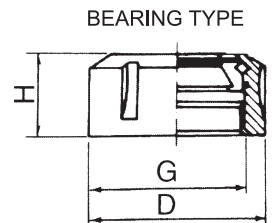

Fig.5 ER40,50KM

ER WRENCHES SYSTEM DIN 6499



ERMS



ERUM

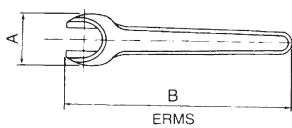

ERMS

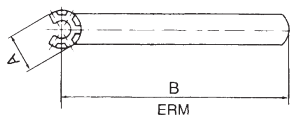

ERM

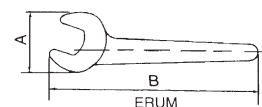

ERUM

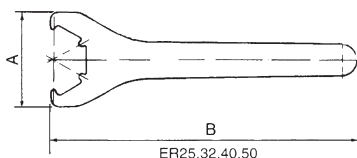

ER25,32,40,50



ERM



ER25,32,40,50

ORDER NO.	TYPE	A	L	KGS	CODE NO.
V-821	ER11MS	22	100	0.05	3015-101
V-822	ER11M	17	95	0.05	3015-102
V-823	ER16M	22.5	118	0.06	3015-103
V-815	ER16UM	44	140	0.08	3015-104
V-824	ER20M	28	130	0.08	3015-105
V-816	ER20UM	53	170	0.1	3015-106
V-811	ER25 UM	65	210	0.2	3015-107
V-812	ER32UM	75	250	0.4	3015-108
V-813	ER40UM	90	290	0.5	3015-109
V-814	ER50	110	350	0.9	3015-110



ER Spring Collet Chuck System MAS403

Collet Holders With BT Taper Shank (For CNC Machine Center)

BT-SHANK

ER-32 ER-40

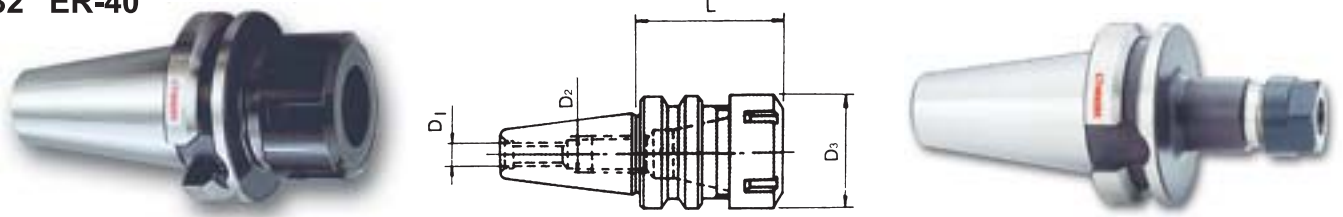

RDER NO.	TAPER	COLLET TYPE	D1	D2	D3	L	KGS	CODE NO.	
V-700	BT30	ER32	M12	M12x1.75P	50	60	0.6	3031-303	
V-703A	BT40	ER32	M16X2.0P	M22x1.5P	50	70	1.2	3032-305	
V-703B		ER32	M16X2.0P	M22x1.5P	50	100	1.4	3032-306	
V-704		ER40	M16X2.0P	M22x1.5P	63	80	2.0	3032-307	
V-705	BT50	ER32	M24X3.0P	M28x1.5P	50	100	3.4	3033-305	
V-706B		ER40	M24X3.0P	M28x1.5P	63	150	5.8	3033-307	
V-707		ER50	M12	M36x1.5P	78	100	4.8	3033-308	
V-710	BT30	ER11	M12	M12x1.75P	19	60	0.6	3033-311	
V-711		ER11	M12	M12x1.75P	19	100	0.9	3033-312	
V-712		ER11M	M12	M12x1.75P	16	100	0.9	3033-313	
V-713		ER16	M12	M12x1.75P	28	100	0.9	3033-314	
V-714		ER16M	M12	M12x1.75P	22	100	0.9	3033-315	
V-715		ER20	M12	M12x1.75P	34	60	0.6	3033-316	
V-716		ER20	M12	M12x1.75P	34	100	0.9	3033-317	
V-717		ER20M	M12	M12x1.75P	28	100	0.9	3033-318	
V-718		ER25	M12	M12x1.75P	42	60	0.7	3033-319	
V-719		ER40	M12	M12x1.75P	63	70	0.9	3033-320	
V-720		BT40	ER11	M16	M22x11.5P	19	70	1	3033-321
V-721			ER11	M16	M22x11.5P	19	100	1.5	3033-322
V-722A			ER11M	M16	M22x11.5P	16	100	1	3033-323
V-723A			ER16M	M16	M22x11.5P	22	100	1.5	3033-324
V-723B			ER16M	M16	M22x11.5P	22	150	1.6	3033-330
V-724A	ER20M		M16	M22x11.5P	28	100	1.6	3033-325	
V-724B	ER20M		M16	M22x11.5P	28	150	1.9	3033-331	
V-725	ER25		M16	M22x11.5P	42	70	1.4	3033-326	
V-726	ER25		M16	M22x11.5P	42	100	1.7	3033-327	
V-727	ER50		M16	M22x11.5P	78	90	2	3033-328	

Collet Holders With Extension Type BT Taper Shank

ER-16, ER-20

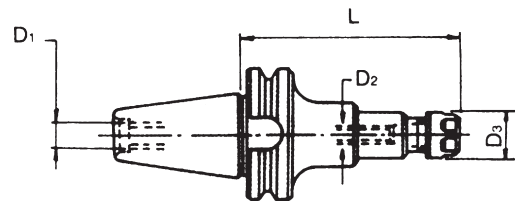

O.	TAPER	COLLET TYPE	D3	L	D1	WEIGHT KGS	CODE NO.	
V-770	BT30	ER16	28	60	M12	0.6	3031-301	
V-772	BT40	ER16	28	70	M16	1.1	3032-301	
V-773		ER16	28	100	M16	1.5	3032-302	
V-774		ER20	34	70	M16	1.1	3032-303	
V-774A		ER16	28	150	M16	1	3032-308	
V-775		ER20	34	100	M16	1.5	3032-304	
V-775A		ER20	34	135	M16	1.6	3032-309	
V-775B		ER20	34	150	M16	1.7	3032-310	
V-775C		ER25	42	150	M16	1.9	3032-311	
V-733		ER32	50	150	M16	2	3033-354	
V-776		BT50	ER16	28	100	M24	4.3	3033-301
V-777			ER16	28	150	M24	4.8	3033-302
V-778			ER20	34	100	M24	4.3	3033-303
V-779		ER20	34	150	M24	4.8	3033-304	
V-743A		BT50	ER16	28	200	M24	7.5	3033-364
V-735			ER20	34	200	M24	5	3033-356
V-736	ER25		42	100	M24	4.8	3033-357	
V-737A	ER25		42	150	M24	5.8	3033-358	
V-744A	ER25		42	200	M24	8	3033-365	
V-738A	ER32		50	150	M24	5.8	3033-359	
V-739A	ER32		50	200	M24	6.5	3033-360	
V-740A	ER40		63	100	M24	5	3033-361	
V-741A	ER40		63	200	M24	7.5	3033-362	
V-742A	ER50		78	150	M24	6	3033-363	



ER Spring Collet Chuck System MAS403

Collet Chuck Kit With BT Taper Shank

Including shank, full set of collets, wrench and case.(ER16 no Wrench)

- 1.ER16, ER20 PACKED IN WOODEN BOX
- 2.ER32, ER40, ER50, PACKED IN PLASTIC BOX
- 3.PACKAGE INCLDING : CHUCK, COLLET, WRENCH, BOX

Please notify the taper size, collet type, set range,and set numbers when ordering.



**BT-SHANK
DIN 6499**

ORDER NO.	BT TAPER	COLLET TYPE	SET RANGE	COLLET PCS	WEIGHT KGS	CODE NO.
V-780	BT30-60L	ER16	1-10	10	1.9	3031-401
V-780A	BT30-100L	ER16	1-10	10	2	3031-406
V-781	BT40-70L	ER16	1-10	10	2.3	3032-401
V-782	BT40-100L	ER16	1-10	10	2.7	3032-402
V-783	BT30-60L	ER20	2-13	12	2.5	3031-402
V-783A	BT30-100L	ER20	2-13	12	2.6	3032-413
V-783B	BT30-60L	ER25	2-16	15	2.5	3032-414
V-783C	BT30-60L	ER25	4-16	7	2.8	3032-415
V-784	BT40-100L	ER20	2-13	12	3	3032-403
V-784A	BT40-70L	ER20	2-13	12	2.8	3032-416
V-784B	BT40-70L	ER25	2-16	15	3.2	3032-417
V-784C	BT40-100L	ER25	4-16	7	3	3032-418
V-785	BT30-60L	ER32	3-20	18	4.4	3031-403
V-786	BT30-60L	ER32	4-20	11	3.8	3031-404
V-787	BT30-60L	ER32	6-20	6	3.4	3031-405
V-788	BT40-70L	ER32	3-20	18	5.2	3032-404
V-789	BT40-70L	ER32	4-20	11	4.2	3032-405
V-790	BT40-70L	ER32	6-20	6	3.8	3032-406
V-791	BT40-100L	ER32	3-20	18	5.7	3032-407
V-792	BT40-100L	ER32	4-20	11	4.7	3032-408
V-793	BT40-100L	ER32	6-20	6	4.3	3032-409
V-794	BT40-80L	ER40	4-26	23	8.9	3032-410
V-795	BT40-80L	ER40	4-26	15	7.6	3032-411
V-796	BT40-80L	ER40	6-25	7	6	3032-412
V-797	BT50-100L	ER40	4-26	23	11.3	3033-401
V-798	BT50-100L	ER40	4-26	15	10	3033-402
V-799	BT50-100L	ER40	6-26	7	8.5	3033-403
V-737	BT50-150L	ER40	4-26	23	12.2	3033-404
V-738	BT50-150L	ER40	4-26	15	11	3033-405
V-739	BT50-150L	ER40	6-26	7	9.5	3033-406
V-740	BT50-100L	ER50	12-34	12	12	3033-407
V-740A	BT40-90L	ER50	12-34	12	9	3033-408
V-740B	BT50-100L	ER32	3-20	18	7.5	3033-409



ER Collet Chuck System

MAS403 BT30/40/50 SHANK

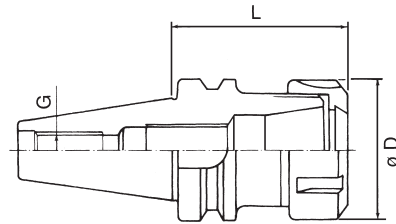

ULTRA PRECISION TYPE
MAX. SPEED: 10,000RPM; G6.3
DYNAMIC BALANCE TESTED

R NO.				EIGHT(Kgs)	CODE NO.
BT30-ER11-60-B	60	19	ER11	0.5	3033-500
BT30-ER11-100-B	100	19	ER11	0.55	3033-501
BT30-ER16-60-B	60	28	ER16	0.5	3033-502
BT30-ER16-100-B	100	28	ER16	0.7	3033-503
BT30-ER20-60-B	60	34	ER20	0.55	3033-504
BT30-ER20-100-B	100	34	ER20	0.8	3033-505
BT30-ER25--60-B	60	42	ER25	0.6	3033-506
BT30-ER32-60-B	60	50	ER32	0.65	3033-507
BT30-ER40-70-B	70	63	ER40	0.9	3033-508
BT40-ER11-70-B	70	19	ER11	1	3033-509
BT40-ER11-100-B	100	19	ER11	1.1	3033-510
BT40-ER16-70-B	70	28	ER16	1.1	3033-511
BT40-ER16-100-B	100	28	ER16	1.2	3033-512
BT40-ER16-150-B	150	28	ER16	1	3033-513
BT40-ER20-70-B	70	34	ER20	1.2	3033-514
BT40-ER20-100-B	100	34	ER20	1.4	3033-515
BT40-ER20-135-B	135	34	ER20	1.6	3033-516
BT40-ER20-150-B	150	34	ER20	1.7	3033-517
BT40-ER25-70-B	70	42	ER25	1.2	3033-518
BT40-ER25-100-B	100	42	ER25	1.45	3033-519
BT40-ER25-150-B	150	42	ER25	1.9	3033-520
BT40-ER32-70-B	70	50	ER32	1.3	3033-521



ER-SK Taper shank

& COLLET CHUCK SET
DIN*69871

COLLET HOLDER WITH SK-SHANK DIN 69871

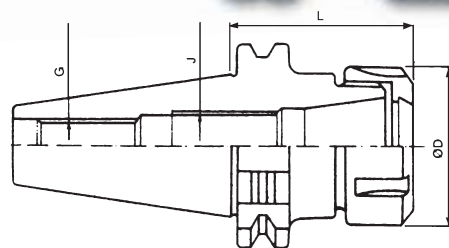
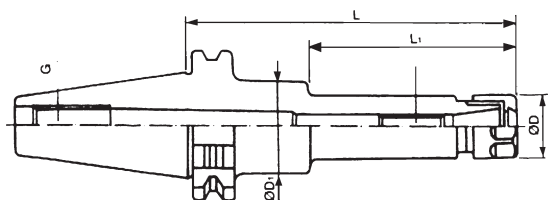

ORDER NO.	COLLET TYPE	TAPER	D			WEIGHT KGS	CODE NO.
V-741	ER16	SK40	28	100	M16	1.5	3029-301
V-741A	ER16	SK30	28	60	M12	0.45	3029-311
V-741B	ER16	SK50	28	100	M24	3.5	3029-317
V-742	ER20	SK40	34	100	M16	1.5	3029-302
V-742A	ER20	SK30	34	60	M12	0.5	3029-312
V-742B	ER25	SK30	42	60	M12	0.55	3029-313
V-742C	ER16	SK40	28	70	M16	1	3029-315
V-742D	ER20	SK40	34	70	M16	1.1	3029-316
V-742E	ER20	SK50	34	100	M24	3.5	3029-318
V-743	ER26	SK50	28	150	M24	4.8	3030-301
V-744	ER20	SK50	34	150	M24	4.8	3030-302

ORDER NO.	COLLET TYPE	TAPER	D			WEIGHT KGS	CODE NO.
V-745	ER32	SK40	50	70	M16	1.2	3029-303
V-745A	ER32	SK30	50	60	M12	06.	3029-314
V-745B	ER32	SK50	50	100	M24	3.7	3029-320
V-746	ER40	SK40	63	80	M16	2	3029-304
V-747	ER40	SK50	63	100	M24	4.3	3030-303
V-749	ER25	SK40	42	70	M16	1.1	3030-304
V-749A	ER25	SK50	42	100	M24	3.7	3029-319

COLLET CHUCK KIT WITH SK-SHANK DIN 69871

INCLUDING SHANK, FULL SET OF COLLETS,
WRENCH AND CASE.



	ER TYPE	SK TAPER	SET RANGE	SET PCS	WEIGHT KGS	CODE NO.
V-751	ER16	SK40-70L	1-10	10PCS	2.3	3029-401
V-751A	ER16	SK30-60L	1-10	10PCS	1.8	3029-420
V-752	ER20	SK40-70L	2-13	12PCS	3	3029-402
V-752A	ER20	SK30-60L	2-13	12PCS	2.4	3029-421
V-752B	ER25	SK30-60L	2-16	15PCS	2.7	3029-422
V-753	ER32	SK40-70L	3-20	18PCS	5.2	3029-403
V-754	ER32	SK40-70L	4-20	11PCS	4.2	3029-404
V-754A	ER32	SK30-60L	3-20	18PCS	4.2	3029-423
V-754B	ER32	SK50-100L	3-20	18PCS	7	3029-424
V-755	ER32	SK40-70L	6-20	6PCS	3.8	3029-405
V-756	ER40	SK40-80L	4-26	23PCS	8.9	3029-406
V-757	ER40	SK40-80L	4-26	15PCS	7.6	3029-407
V-758	ER40	SK40-80L	6-25	7PCS	6	3029-408
V-759	ER40	SK50-100L	4-26	23PCS	11.3	3030-401
V-760	ER40	SK50-100L	4-26	15PCS	10	3030-402
V-761	ER40	SK50-100L	6-26	7PCS	8.5	3030-403
V-762	ER25	SK40-70L	2-16	15PCS	3.5	3029-409
V-763	ER25	SK40-70L	4-16	7PCS	3.2	3029-410

ER16, ER20 PACKED IN WOODEN CASE
ER32, ER40 PACKED IN PLASTIC CASE



ER-CAT Taper Shank Collet Chuck

COLLET HOLDER WITH CAT-SHANK

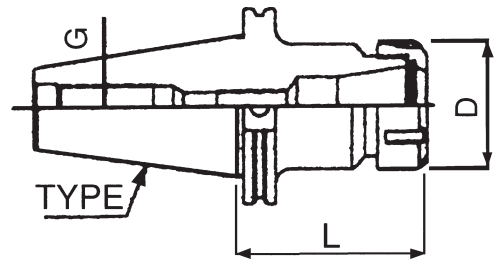

ORDER NO.	COLLET TYPE	TAPER	D	L	G	WEIGHT KGS	CODE NO.
V-870	ER16	CAT30	28	2"	1/2"-13	0.8	3034-301
V-871	ER16	CAT40	28	3"	5/8"-11	1.2	3035-301
V-872	ER20		34	3"		1.3	3035-302
V-873	ER25		42	2 1/2"		1.3	3035-303
V-874	ER32		50	2 1/2"		1.4	3035-304
V-875	ER40		63	3"		1.9	3035-305
V-876	ER40	CAT50	63	3 1/2"	1"/8"	4	3036-301

COLLET CHUCK KIT WITH CAT-SHANK

INCLUDING SHANK, FULL SET OF COLLETS, WRENCH AND CASE.



- 1.ER16, ER20, ER25 PACKED IN WOODEN BOX
- 2.ER32, ER40 PACKED IN PLASTIC BOX
- 3.PACKAGE INCLUDING : CHUCK , COLLET, WRENCH , BOX

ORDER NO.	COLLET TYPE	CAT TAPER	SET RANGE	SET PCS	WEIGHT KGS	CODE NO.
V-877	ER16	CAT30-2"L	1.0-10	10	1.7	3034-401
V-878		CAT40-3"L	1.0-10	10	2.3	3035-401
V-879	ER20	CAT40-3"L	2.0-13	12	2.5	3035-402
V-880	ER25	CAT40-2 1/2"L	2.0-16	15	3	3035-403
V-881		CAT40-2 1/2"L	4.0-16	7	2.8	3035-404
V-882	ER32	CAT40-2 1/2"L	3.0-20	18	5.2	3035-405
V-883		CAT40-2 1/2"L	4.0-20	11	4.2	3035-406
V-884		CAT40-2 1/2"L	6.0-20	6	3.8	3035-407
V-885	ER40	CAT40-3"L	4.0-26	23	8.9	3035-408
V-886		CAT40-3"L	4.0-26	15	7.6	3035-409
V-887		CAT40-3"L	6.0-25	7	6	3035-410
V-888	ER40	CAT50-3 1/2"L	4.0-26	23	11.2	3036-401
V-889		CAT50-3 1/2"L	4.0-26	15	9.8	3036-402
V-890		CAT50-3 1/2"L	6.0-25	7	8.3	3036-403



Milling Chuck

DIN 6388 # 25 SERIES
DIN 2080 NT-SHANK

COLLET HOLDER WITH #25 COLLET CHUCK DIN 6388 TYPE A OZ-25

1. Best selected quality tool steel hardened & Precision ground.
2. Accuracy of concentric to within 0.008" per inch.(0.02mm per 25mm)
3. High rigidity & Clamping force.
4. 1 set including 1 chuck shank holder
1 wrench 1 case.
7 or 15 pcs of collet.



CHUCK SHANK ONLY

ORDER NO.	CHUCK SHANK	DRAW BAR THREADS		WEIGHT/SET (PLASTIC CASE)	MEAS. CFT	CODE NO.
		SAE	METRIC			
VB-MT-2	MT2	3/8"-16	M10X1.5P	1kg	0.3	3101-001
VB-MT-3	MT3	3/8"-16	M10X1.5P	1kg	0.3	3101-002
		1/2"-12				
		1/2"-13	M12X1.75P			
VB-MT-4	MT4	5/8"-11	M16X2.0P	1.2kg	0.3	3101-003
VB-MT-5	MT5	1"-8	M24X3.0P	2kg	0.5	3101-004
VB-R8	R-8	7/16"-20		1.2kg	0.3	3101-005
VB-NT30	NT30	3/8"-16	M12X1.75P	1kg	0.3	3101-006
		1/2"-12				
		1/2"-13				
VB-NT40	NT40	5/8"-11	M16X2.0P	1.3kg	0.3	3101-007
VB-NT50	NT50	1"-8	M24X3.0P	3.2kg	0.5	3101-008

Please Notify the Draw Bar Thread Size When ordering.

MILLING COLLET CHUCK KIT

Including Shank, full set of collets, wrench and case.

Collet Chuck Kit



DIN 6388
OZ-25 TYPE

FULL SET

ORDER NO.	COLLETS SIZE OZ-25 TAPER	COLLETS	PCS	WEIGHT)	CODE NO.
VB-102	NT30		15	5.2	3101-102
VB-103	NT40		7	4	3101-103
VB-104	NT40		15	5.5	3101-104
VB-105	NT50	Inch	7	6.5	3101-105
VB-106	NT50	1/8"-1"15PCS	15	8.5	3101-106
VB-107	MT3	1/4"-1"7PCS	7	3.7	3101-107
VB-108	MT3		15	5.2	3101-108
VB-109	MT4	Metric	7	3.9	3101-109
VB-110	MT4	3mm-25mm	15	5.4	3101-110
VB-111	MT5	15pcs	7	4.7	3101-111
VB-112	MT5	6mm-25mm 7pcs	15	6.2	3101-112
VB-113	R8		7	3.7	3101-113
VB-114	R8		15	5.2	3101-114
VB-115	MT2		7	3.6	3101-115
VB-116	MT2		15	5.1	3101-116

Please Notify the Type Size, Collet Type, Set Range, and Set Numbers When Ordering.

CONTENT COLLET SET SIZE

7 PCS/SET	MM	6,8,10,12,16,20,25MM
	INCH	1/4",5/16",3/8",1/2",5/8",3/4",1"
15 PCS/SET	MM	3,4,5,6,7,8,9,10,11,12,13,16,18,20,25MM
	INCH	1/8",3/16",1/4",5/16",3/8",7/16",1/2",9/16",5/8",11/16",3/4",13/16",7/8",15/16",1"



Milling Clamping Nuts & Wrench For OZ

DIN 6388 #16,#25,#32 SERIES

COLLET DIN 6388, TYPE A

COLLET MUST BE ASSEMBLED INTO THE CLAMPING NUT BEFORE INSERTING INTO THE CHUCK

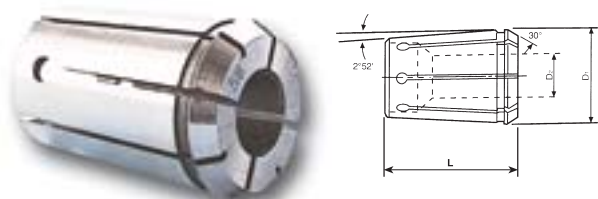

METRIC

ORDER NO.	D1	L	D2(MM)
OZ-16-□	25.5	40	2, 3, 4, 5, 6, 7, 8, 9, 10, 11, 12, 13, 14, 15, 16
OZ-25-□	35.05	52	3, 4, 5, 6, 7, 8, 9, 10, 11, 12, 13, 14, 15, 16, 18, 20, 25
OZ-32-□	44	60	6, 8, 10, 12, 16, 20, 25, 32

INCH

ORDER NO.	D1	L	D2(INCH)
OZ-25-□	35.05	52	1/8", 3/16", 1/4", 5/16", 3/8", 7/16", 1/2", 9/16", 5/8", 11/16", 3/4", 13/16", 7/8", 15/16", 1"
OZ-32-□	43.7	60	1/4", 5/16", 3/8", 7/16", 1/2", 9/16", 5/8", 11/16", 3/4", 13/16", 7/8", 15/16", 1", 1 1/8", 1 1/4"

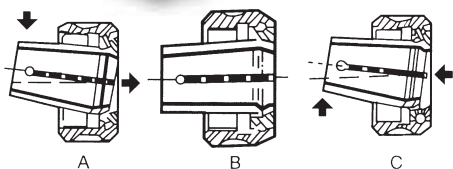

■ RANGE SIZE:3-25(1/8"-1")

OZ-25 ■ D:35.05 ■ L:52 ■ TAPER:1:10 ■ WEIGHT:0.18KGS

ORDER NO.	CODE NO.	MM SIZE	ORDER NO.	CODE NO.	MM SIZE	ORDER NO.	CODE NO.	INCH	ORDER NO.	CODE NO.	INCH
OZ-2503	3100-101	3.0	OZ-2515	3100-113	15	OZ-2526	3100-124	1/8"	OZ-2538	3100-136	7/8"
OZ-2504	3100-102	4.0	OZ-2516	3100-114	16	OZ-2527	3100-125	3/16"	OZ-2539	3100-137	15/16"
OZ-2505	3100-103	5.0	OZ-2517	3100-115	17	OZ-2528	3100-126	1/4"	OZ-2540	3100-138	1"
OZ-2506	3100-104	6.0	OZ-2518	3100-116	18	OZ-2529	3100-127	5/16"			
OZ-2507	3100-105	7.0	OZ-2519	3100-117	19	OZ-2530	3100-128	3/8"			
OZ-2508	3100-106	8.0	OZ-2520	3100-118	20	OZ-2531	3100-129	7/16"			
OZ-2509	3100-107	9.0	OZ-2521	3100-119	21	OZ-2532	3100-130	1/2"			
OZ-2510	3100-108	10	OZ-2522	3100-120	22	OZ-2533	3100-131	9/16"			
OZ-2511	3100-109	11	OZ-2523	3100-121	23	OZ-2534	3100-132	5/8"			
OZ-2512	3100-110	12	OZ-2524	3100-122	24	OZ-2535	3100-133	11/16"			
OZ-2513	3100-111	13	OZ-2525	3100-123	25	OZ-2536	3100-134	3/4"			
OZ-2514	3100-112	14				OZ-2537	3100-135	13/16"			

DIN6388 32# ■ RANGE SIZE:6-32(1/4"-1 1/4")

OZ-32 ■ D:43.7 ■ L:60 ■ TAPER:1:10 ■ WEIGHT:0.25KGS



■ DIN 6388 16#

■ O Z-16 COLLET

ORDER NO.	CODE NO.	MM SIZE	ORDER NO.	CODE NO.	MM SIZE	ORDER NO.	CODE NO.	INCH	ORDER NO.	CODE NO.	MM
OZ-3206	3100-201	6.0	OZ-3220	3100-215	20	OZ-3233	3100-228	1/4"	OZ-1602	3100-001	2.0
OZ-3207	3100-202	7.0	OZ-3221	3100-216	21	OZ-3234	3100-229	5/16"	OZ-1603	3100-002	3.0
OZ-3208	3100-203	8.0	OZ-3222	3100-217	22	OZ-3235	3100-230	3/8"	OZ-1604	3100-003	4.0
OZ-3209	3100-204	9.0	OZ-3223	3100-218	23	OZ-3236	3100-231	7/16"	OZ-1605	3100-004	5.0
OZ-3210	3100-205	10	OZ-3224	3100-219	24	OZ-3237	3100-232	1/2"	OZ-1606	3100-005	6.0
OZ-3211	3100-206	11	OZ-3225	3100-220	25	OZ-3238	3100-233	9/16"	OZ-1607	3100-006	7.0
OZ-3212	3100-207	12	OZ-3226	3100-221	26	OZ-3239	3100-234	5/8"	OZ-1608	3100-007	8.0
OZ-3213	3100-208	13	OZ-3227	3100-222	27	OZ-3240	3100-235	11/16"	OZ-1609	3100-008	9.0
OZ-3214	3100-209	14	OZ-3228	3100-223	28	OZ-3241	3100-236	3/4"	OZ-1610	3100-009	10
OZ-3215	3100-210	15	OZ-3229	3100-224	29	OZ-3242	3100-237	13/16"	OZ-1611	3100-010	11
OZ-3216	3100-211	16	OZ-3230	3100-225	30	OZ-3243	3100-238	7/8"	OZ-1612	3100-011	12
OZ-3217	3100-212	17	OZ-3231	3100-226	31	OZ-3244	3100-239	15/16"	OZ-1613	3100-012	13
OZ-3218	3100-213	18	OZ-3232	3100-227	32	OZ-3245	3100-240	1"	OZ-1614	3100-013	14
OZ-3219	3100-214	19				OZ-3246	3100-241	1-1/8"	OZ-1615	3100-014	15
						OZ-3247	3100-242	1-1/4"	OZ-1616	3100-015	16

BALL BEARING, NUTS FOR COLLETS DIN6388, TYPE A

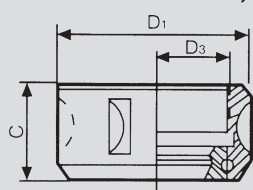

Unit:mm

ORDER NO.	C	D1	D3	COLLETS	CODE NO.
OZ-25N	30	60	M48X2	OZ-25	3100-301
OZ-32N	33	72	M60X2.5	OZ-32	3100-302

WRENCH FOR COLLETS DIN6388 TYPE A

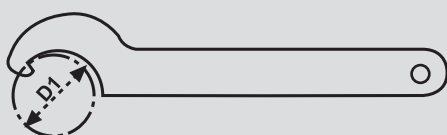

Unit:mm

ORDER NO.	D1	COLLETS	CODE NO.
OZ-25W	60	OZ-25	3100-310
OZ-32W	72	OZ-32	3100-311



Milling Collet Chuck

DIN 6388 # 25 SERIES

MAS 403 BT-SHANK

OZ-25

COLLET HOLDER WITH BT-SHANK



ORDER NO.	PER	DIN 6388		DRAW BAR	WEIGHT KGS	CODE NO.
VB-BT40	BT40	#25	80	M16X2.0P	1.5	3101-009
VB-BT50	BT50	#25	100	M24X3.0P	5	3101-010
			150	M24X3.0P	5.8	3101-011

Milling Collet Chuck Kit

Including shank, full set of collets, wrench and case.



METRIC COLLET SYSTEM

DER NO.	TAPER	PCS/SET	WEIGHT KGS	CODE NO.
VB-241	BT40	7	4.4	3101-117
VB-242		15	5.9	3101-118
VB-251	BT50	7	7.5	3101-119
VB-252		15	9.5	3101-120

INCH COLLET SYSTEM

ORDER NO.	TAPER	PCS/SET	WEIGHT KGS	CODE NO.
VB-231	BT40	7	4.4	3101-121
VB-232		15	5.9	3101-122
VB-233	BT50	7	7.5	3101-123
VB-234		15	9.5	3101-124

CONTENT COLLET SET SIZE

SET SIZE
7PCS: 6, 8, 10, 12, 16, 20, 25mm
15PCS: 3, 4, 5, 6, 7, 8, 9, 10, 11, 12, 13, 16, 18, 20, 25mm

INCH RANGE SET SIZE

7PCS: 1/4", 5/16", 3/8", 1/2", 5/8", 3/4", 1"
15PCS: 1/8", 3/16", 1/4", 5/16", 3/8", 7/16", 1/2", 9/16", 5/8", 11/16", 3/4", 13/16", 7/8", 15/16", 1"



Milling Collet Chuck

DIN 6388 # 32 SERIES

DIN 2080 NT-SHANK

COLLET HOLDER WITH ISO-SHANK
OZ-32



ORDER NO.	TAPER	DIN 6388	DRAW BAR	WEIGHT KGS	CODE NO.
VB-130	NT30	#32	1.M12X1.75P 2.1/2"-12W	2	3102-006
VB-131	NT40	#32	1.M16X2.0P 2.5/8"-11W	2.2	3102-001
VB-132	NT50	#32	1.M24X3.0P 2.1"-8W	4.8	3102-002

Milling Collet Chuck Kit

Including Shank, full set of collets, wrench and case.

OZ-32 DIN 6388



METRIC COLLET SYSTEM

ORDER NO.	TAPER	PCS/SET	WEIGHT KGS	CODE NO.
VB-121	NT40	8	7.5	3102-101
VB-121B	NT40	15	9.2	3102-102
VB-122	NT50	8	9.8	3102-103
VB-122B	NT50	15	11.8	3102-104
VB-123	NT30	8	7	3102-090
VB-123B	NT30	15	9	3102-091
VB-124	MTB5	8	8	3102-092
VB-124B	MTB5	15	10	3102-093

INCH COLLET SYSTEM

ORDER NO.	TAPER	PCS/SET	WEIGHT KGS	CODE NO.
VB-162	NT30	10	7	3102-094
VB-162B	NT30	15	9	3102-095
VB-163	NT40	10	7.2	3102-105
VB-164	NT40	15	9.2	3102-106
VB-165	NT50	10	9.8	3102-107
VB-166	NT50	15	11.8	3102-108
VB-167	MTB5	10	8	3102-096
VB-167B	MTB5	15	10	3102-097

CONTENT COLLET SET SIZE

METRIC RANGE SET SIZE
8PCS: 6, 8, 10, 12, 16, 20, 25, 32mm
15PCS: 6, 7, 8, 9, 10, 11, 12, 13, 16, 18, 20, 25, 26, 30, 32mm

INCH RANGE SET SIZE
10PCS: 1/4", 5/16", 3/8", 1/2", 5/8", 3/4", 7/8", 1", 1-1/8", 1-1/4"
15PCS: 1/4", 5/16", 3/8", 7/16", 1/2", 9/16", 5/8", 11/16", 3/4", 13/16", 7/8", 15/16", 1", 1-1/8", 1-1/4"



Milling Collet Chuck

DIN 6388 # 32 SERIES

COLLET HOLDER WITH BT-SHANK
OZ-32 MAS 403



ORDER NO.		88	L	DRAW BAR	WEIGHT KGS	CODE NO.
VB-226	BT40-OZ-32	#32	90	M16X2.0P	2	3102-003
VB-227	BT50-OZ-32	#32	100	M24X3.0P	5	3102-004
VB-228			150	M24X3.0P	6	3102-005

Milling Collet Chuck Kit

Including Shank, full set of collets, wrench and case.

#32 SERIES BT-TYPE

MAS 403 BT-SHANK



METRIC COLLET SYSTEM SET

ORDER NO.	TAPER	PCS/SET	WEIGHT KGS	CODE NO.
VB-243	BT-40	8	7.4	3102-109
VB-244		15	9.4	3102-110
VB-253	BT-50	8	10	3102-111
VB-254		15	12	3102-112

INCH COLLET SYSTEM SET

ORDER NO.	TAPER	PCS/SET	WEIGHT KGS	CODE NO.
VB-256	BT-40	10	7.4	3102-113
VB-257		15	9.4	3102-114
VB-258	BT-50	10	10	3102-115
VB-259		15	12	3102-116

CONTENT COLLET SET SIZE

METRIC RANGE SET SIZE

8PCS: 6, 8, 10, 12, 16, 20, 25, 32mm
15PCS: 6, 8, 10, 12, 13, 14, 15, 16, 18, 20, 22, 25, 26, 30, 32mm

INCH RANGE SET SIZE

10PCS: 1/4", 5/16", 3/8", 1/2", 5/8", 3/4", 7/8", 1", 1-1/8", 1-1/4"
15PCS: 1/4", 5/16", 3/8", 7/16", 1/2", 9/16", 5/8", 11/16", 3/4", 13/16", 7/8", 15/16", 1", 1-1/8", 1-1/4"



Milling Collet Chuck

DIN 6388 # 25,#32 SERIES

COLLET HOLDER WITH DIN 69871A & CAT TYPE



DIN 69871A & CAT SHANK

ORDER NO.	TAPER	DIN 6388	DRAW BAR	WEIGHT KGS	CODE NO.
VB-261	SK40-OZ25-80L	#25	M16X2.0P	1.9	3101-011
VB-262	SK50-OZ25-100L		M24X3.0P	4.2	3101-012
VB-263	CAT40-OZ25-3"L		5/8"-11W	1.9	3101-013
VB-264	CAT50-OZ25-3 1/2 L		1"-8W	4	3101-014
VB-265	SK40-OZ32-80L	#32	M16X2.0P	2.3	3102-011
VB-266	SK50-OZ32-100L		M24X3.0P	5	3102-012
VB-267	CAT40-OZ32-3"L		5/8"-11W	2.3	3102-013
VB-268	CAT50-OZ32-3 1/2"L		1"-8W	5	3102-014

Milling Collet Chuck Kit

Including Shank, full set of collets, wrench and case.



METRIC COLLET SYSTEM SET DIN69871A SK-TYPE WITH #25,#32

ORDER NO.	COLLET HOLDER	TYPE	DIN 6388	RANGE	PCS	KGS	CODE NO.
VB-271	SK40-OZ25-80L	SK40	#25	3.0-25	15PCS	5.7	3101-125
VB-272	SK40-OZ25-80L		#25	6.0-25	7PCS	4.2	3101-126
VB-273	SK40-OZ32-90L		#32	6.0-32	15PCS	9.2	3101-127
VB-274	SK40-OZ32-90L		#32	6.0-32	8PCS	7.2	3101-128
VB-275	SK50-OZ25-100L	SK50	#25	3.0-25	15PCS	9.3	3101-129
VB-276	SK50-OZ25-100L		#25	6.0-25	7PCS	7.3	3101-130
VB-277	SK50-OZ32-100L		#32	6.0-32	15PCS	11.8	3102-117
VB-278	SK50-OZ32-100L		#32	6.0-32	8PCS	9.8	3102-118

METRIC COLLET SYSTEM SET CAT-TYPE WITH #25,#32

ORDER NO.	COLLET HOLDER	TYPE	DIN 6388	RANGE	SET PCS	KGS	CODE NO.
VB-281	CAT40-OZ25-3"L	CAT40	#25	1/8"-1	15PCS	5.7	3101-131
VB-282	CAT40-OZ25-3"L		#25	1/4"-1	7PCS	4.2	3101-132
VB-286	CAT40-OZ32-3"L		#32	1/4"-1 1/4"	15PCS	9.2	3102-119
VB-287	CAT40-OZ32-3"L		#32	1/4"-1 1/4"	10PCS	7.2	3102-120
VB-288	CAT50-OZ25-3 1/2 "L	CAT50	#25	1/8"-1"	15PCS	9.3	3101-133
VB-289	CAT50-OZ25-3 1/2 "L		#25	1/4"-1"	7PCS	7.3	3101-134
VB-290	CAT50-OZ32-3 1/2 "L		#32	1/4"-1 1/4"	15PCS	11.8	3102-121
VB-291	CAT50-OZ32-3 1/2 "L		#32	1/4"-1 1/4"	10PCS	10	3102-122



Posi-lock Milling Collet Chuck

COLLET HOLDER WITH MT, R-8, NT TAPER SHANK
 POSI-LOCK COLLET TYPE



ORDER NO.	TAPER	WEIGHT KGS	DRAW BAR		CODE NO.
VC-115	MT2	0.7	1.M10x1.5	2.3/8"-16	3203-001
VC-116	MT3	0.9	1.M12x1.75	2.M10X1.5 3.3/8"-16	3203-002
VC-117	MT4	1	1.M16X2.0P	2.5/8"-11	3203-003
VC-118	R8	1	1.7/16"-20UNF		3203-004
VC-123	NT30	1	1.M12X1.75	2.1/2"-12	3203-005
VC-124	NT40	1.2	1.M16X2.0	2.5/8"-11	3203-006
VC-125	NT50	3	1.M24X3.0	2.1"-8	3203-007

POSI-LOCK MILLING COLLET CHUCK KIT

Including Collet Chuck, Full Set of Collets and Wrench
 Compact design for maximum clearance. Gradual collier taper for powerful clamping action over entire collet. Fast & simple tool changing.

ORDER NO.	TAPER	DRAW BAR	COLLET SIZE	COLLET PCS	WEIGHT KGS	CODE NO.
VC-101	MT2	1.M10x1.5P 2.3/8"-16	METRIC	4	1.8	3203-101
VC-101I			INCH	4	1.8	3203-102
VC-101A			MM+INCH	8	2.3	3203-103
VC-102	MT3	1.M10x1.5P 2.M12X1.75 3.3/8"-16 4.1/2"-12	METRIC	4	2	3203-104
VC-102I			INCH	4	2	3203-105
VC-102A			MM+INCH	8	5	3203-106
VC-103	MT4	1.M16x2.0P 2.5/8"-11	METRIC	4	2	3203-107
VC-103I			INCH	4	2	3203-108
VC-103A			MM+INCH	8	2.5	3203-109
VC-104	R8	1.7/16"-20UNF	METRIC	4	2.2	3203-110
VC-104I			INCH	4	2	3203-111
VC-104A			MM+INCH	8	2.5	3203-112
VC-105	NT30	1.M12x1.75P 2.1/2"-12	METRIC	4	2	3203-113
VC-105I			INCH	4	2	3203-114
VC-105A			MM+INCH	8	2.5	3203-115
VC-106	NT40	1.M16x2.0P 2.5/8"-11	METRIC	4	2.3	3203-116
VC-106I			INCH	4	2.3	3203-117
VC-106A			MM+INCH	8	2.8	3203-118
VC-107	NT50	1.M24x3.0P 2.1"-8	METRIC	4	4.3	3203-119
VC-107I			INCH	4	4.3	3203-120
VC-107A			MM+INCH	8	4.8	3203-121



EACH COLLET WEIGHT IS 0.09kgs

ORDER NO.	SIZE	CODE NO.
PLI- 1/4	1/4"	3203-130
PLI- 3/8	3/8"	3203-131
PLI- 1/2	1/2"	3203-132
PLI- 5/8	5/8"	3203-133
PLM- 6	6mm	3203-134
PLM- 10	10mm	3203-135
PLM- 12	12mm	3203-136
PLM- 16	16mm	3203-137

COLLET SET RANGE SIZE
METRIC 4PCS:6,10,12,16mm
INCH 4PCS:1/4",3/8",1/2",5/8"
SIZE 8PCS:6,10,12,16mm,1/4",3/8",1/2",5/8"

COLLET SIZE FOR POSI-LOCK

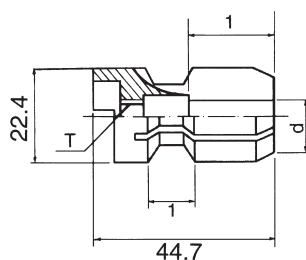

INDIVIDUAL UNIT

ORDER NO.	Q'TY	T	d COLLET SIZE
PLI-□	1PC	5/8"-20TPI	∅ 1/4",3/8",1/2",5/8"
PLM-□	1PC	M16-1.25P	∅ 6,10,12,16mm

FULL SET

ORDER NO.	COLLET SIZE	WEIGHT (kg)	DE
VC-111	4pcs - 6,10,12,16mm	0.36	3203-200
VC-112	4pcs - 1/4",3/8",1/2",5/8"	0.36	3203-201
VC-113	8pcs - 6,10,12,16mm,1/4",3/8",1/2",5/8"	0.72	3203-202



Multi-lock Milling Chuck

COLLET HOLDER WITH ISO, BT & SK TAPER SHANK
 STRAIGHT COLLET TYPE
 C-32 C-42

NEW

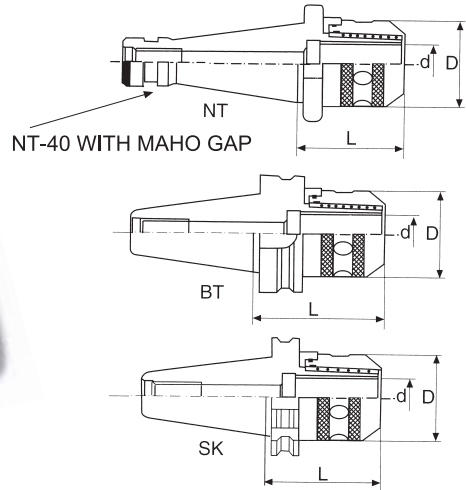

DIN 2080, MAS 403 DIN 69871A
C-20,25,32,42 TYPE

ER NO.	TAPER	CHUCK	d	D	L	DRAW BAR	KGS	CODE NO.
VB-431	NT40	NT40-MC32-95L	32	75	95	5/8"-11	3	3202-001
VB-432		NT40-MC32-95L	32	75	95	M16x2.0P	3	3202-002
VB-433	NT50	NT50-MC32-100L	32	75	100	1"-8	4.5	3202-003
VB-434		NT50-MC32-100L	32	75	100	M24x3.0P	4.5	3202-004
VB-435A	BT40	BT40-MC32-105L	32	75	105	M16x2.0P	3	3202-005
VB-435B		BT40-MC32-150L	32	75	150	M16x2.0P	3.5	3202-020
VB-436	BT50	BT50-MC32-110L	32	75	110	M24x3.0P	5.2	3202-006
VB-437		BT50-MC32-150L	32	75	135	M24x3.0P	7	3202-007
VB-438	NT50	NT50-MC42-110L	42	87	110	1"-8	6	3202-008
VB-439		NT50-MC42-110L	42	87	110	M24x3.0P	6	3202-009
VB-440	BT50	BT50-MC42-115L	42	87	115	M24x3.0P	7	3202-010
VB-441		BT50-MC42-150L	42	87	140	M24x3.0P	8.5	3202-011
VB-442	SK-40	SK40-MC32-100L	32	75	100	M16x2.0P	3	3202-012
VB-443	SK-50	SK50-MC32-105L	32	75	105	M24x3.0P	5.2	3202-013
VB-444A	BT30	BT30-MC20-85	20	52	85	M12x1.75P	2	3202-014
VB-445		BT30-MC25-85	25	58	85	M12x1.75P	2.5	3202-015
VB-446A	BT40	BT40-MC20-80	20	52	80	M16x2.0P	3	3202-016
VB-446B		BT40-MC20-120	20	52	120	M16x2.0P	4	3202-017
VB-447A		BT40-MC25-90	25	58	90	M16x2.0P	4.5	3202-018
VB-447B		BT40-MC25-135	25	58	135	M16x2.0P	5	3202-019
VB-448A	NT30	NT30-MC20-80	20	52	80	1. M12X1.75P 2. 1/2"-12	1.5	3202-030
VB-448B		NT30-MC25-85	25	58	85	1. M12X1.75P 2. 1/2"-12	1.5	3202-031
VB-449A	NT40	NT40-MC20-80	20	52	80	1. M16X2.0P 2. 5/8"-11	2	3202-032
VB-449B		NT40-MC25-85	25	58	85	1. M16X2.0P 2. 5/8"-11	2	3202-033
VB-450	SK30	SK30-MC20-95	20	52	95	M12X1.75P	1.5	3202-034
VB-451A	SK40	SK40-MC20-80	20	52	80	M16X2.0P	2	3202-035
VB-451B		SK40-MC25-90	25	58	90	M16X2.0P	2	3202-036
VB-452	SK50	SK50-MC42-110	42	87	110	M24X3.0P	5.7	3202-037



Multi-lock Milling Chuck

MULTI-LOCK MILLING CHUCK KIT

Including shank, full set of collets,
wrench and case.



**DIN 2080 NT-SHANK
MAS 403 BT-SHANK
DIN 69871A SK-SHANK**

ORDER NO.	TAPER	CHUCK	COLLET	DRAW BAR	KGS	CODE NO.
VB-444I	NT40	NT40-MC32-95L	7PCS	5/8"-11	7	3202-101
VB-444		NT40-MC32-95L	7PCS	M16x2.0P	7	3202-102
VB-454I	NT50	NT50-MC32-100L	7PCS	1"-8	9	3202-103
VB-454		NT50-MC32-100L	7PCS	M24x3.0P	9	3202-104
VB-344A	BT40	BT40-MC32-105L	7PCS	M16x2.0P	7	3202-105
VB-344B		BT40-MC32-150L	7PCS	M16x2.0P	11.5	3202-118
VB-354A	BT50	BT50-MC32-110L	7PCS	M24x3.0P	9.5	3202-106
VB-354B		BT50-MC32-150L	7PCS	M24x3.0P	13	3202-119
VB-554	NT50	NT50-MC42-110L	8PCS	M24x3.0P	12	3202-107
VB-554I		NT50-MC42-110L	8PCS	1"-8	12	3202-108
VB-564A	BT50	BT50-MC42-115L	8PCS	M24x3.0P	12	3202-109
VB-564B		BT50-MC42-150L	8PCS	M24x3.0P	14	3202-120
VB-565	SK-40	SK40-MC32-100L	7PCS	M16x2.0P	7	3202-110
VB-566	SK-50	SK50-MC32-105L	7PCS	M24x3.0P	9.5	3202-111
VB-567	BT-30	BT30-MC20-85	6PCS	M12x1.75P	6	3202-112
VB-568		BT30-MC25-85	7PCS	M12x1.75P	7.5	3202-113
VB-569A	BT-40	BT40-MC20-80	6PCS	M16x2.0P	7	3202-114
VB-569B		BT40-MC20-120	6PCS	M16x2.0P	8	3202-115
VB-570A		BT40-MC25-90	7PCS	M16x2.0P	9.5	3202-116
VB-570B		BT40-MC25-135	7PCS	M16x2.0P	10.5	3202-117
VB-571	NT30	NT30-MC20-80L	6PCS	1. M12X1.75P 2. 1/2"-12	4	3202-120
VB-572		NT30-MC25-85L	7PCS	1. M12X1.75P 2. 1/2"-12	4	3202-121
VB-573	NT40	NT40-MC20-80L	6PCS	1. M16X2.0P 2. 5/8"-11	4.5	3202-122
VB-574		NT40-MC25-85L	7PCS	1. M16X2.0P 2. 5/8"-11	4.5	3202-123
VB-575	SK30	SK30-MC20-95L	6PCS	M12X1.75P	4	3202-124
VB-576	SK40	SK40-MC20-80L	6PCS	M16X2.0P	4.5	3202-125
VB-577		SK40-MC25-90L	7PCS	M16X2.0P	4.8	3202-126
VB-578	SK50	SK50-MC42-110L	8PCS	M24X3.0P	12	3202-127



C-20,25,32,42 Collet

C-TYPE COLLET

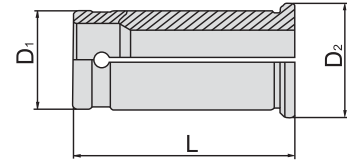

20, 25, 32, 42 STRAIGHT COLLETS

ORDER NO.	COLLET	COLLETS SIZE d INSIDE DIAMETER	D1 O.D.	D2	L	WEIGHT KGS
C-20-□	C-20	6, 8, 10, 12, 16	20	25	52	0.1
C-25-□	C-25	6, 8, 10, 12, 16, 20	25	31	60	0.18
C-32-□	C-32	6, 8, 10, 12, 16, 20, 25	32	37	73	0.22
C-42-□	C-42	6, 8, 10, 12, 16, 20, 25, 32	42	48	80	0.35

ORDER NO.	d	CODE NO.
C-20-6	6	3202-201
C-20-8	8	3202-202
C-20-10	10	3202-203
C-20-12	12	3202-204
C-20-16	16	3202-205

ORDER NO.	d	CODE NO.
C-25-6	6	3202-230
C-25-8	8	3202-231
C-25-10	10	3202-232
C-25-12	12	3202-233
C-25-16	16	3202-234
C-25-20	20	3202-235

ORDER NO.	d	CODE NO.
C-32-6	6	3202-250
C-32-8	8	3202-251
C-32-10	10	3202-252
C-32-12	12	3202-253
C-32-16	16	3202-254
C-32-20	20	3202-255
C-32-25	25	3202-256

ORDER NO.	d	CODE NO.
C-42-6	6	3202-280
C-42-8	8	3202-281
C-42-10	10	3202-282
C-42-12	12	3202-283
C-42-16	16	3202-284
C-42-20	20	3202-285
C-42-25	25	3202-286
C-42-32	32	3202-287

ORDER NO.	d	CODE NO.
C-20-3/16"	3/16"	3202-210
C-20-1/4"	1/4"	3202-211
C-20-5/16"	5/16"	3202-212
C-20-3/8"	3/8"	3202-213
C-20-1/2"	1/2"	3202-214
C-20-5/8"	5/8"	3202-215

ORDER NO.	d	CODE NO.
C-25-3/16"	3/16"	3202-240
C-25-1/4"	1/4"	3202-241
C-25-5/16"	5/16"	3202-242
C-25-3/8"	3/8"	3202-243
C-25-1/2"	1/2"	3202-244
C-25-5/8"	5/8"	3202-245
C-25-3/4"	3/4"	3202-246

ORDER NO.	d	CODE NO.
C-32-3/16"	3/16"	3202-260
C-32-1/4"	1/4"	3202-261
C-32-5/16"	5/16"	3202-262
C-32-3/8"	3/8"	3202-263
C-32-1/2"	1/2"	3202-264
C-32-5/8"	5/8"	3202-265
C-32-3/4"	3/4"	3202-266
C-32-7/8"	7/8"	3202-267
C-32-1"	1"	3202-268

ORDER NO.	d	CODE NO.
C-42-1/4"	1/4"	3202-290
C-42-5/16"	5/16"	3202-291
C-42-3/8"	3/8"	3202-292
C-42-1/2"	1/2"	3202-293
C-42-5/8"	5/8"	3202-294
C-42-3/4"	3/4"	3202-295
C-42-7/8"	7/8"	3202-296
C-42-1"	1"	3202-297
C-42-1 1/2"	1 1/2"	3202-298



C-20,25,32,42 Wrenches



ORDER NO.	L	D			CODE NO.
C-20W	227	52	0.22	C-20	3202-311
C-25W	227	58	0.22	C-25	3202-312
C-32W	260	75	0.33	C-32	3202-313
C-42W	270	87	0.35	C-42	3202-314



Quick-Change Tooling System

MILLING-QUICK CHANGE HOLDER

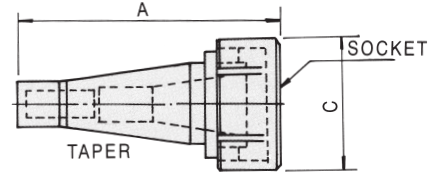

1. QUICK-CHANGE CHUCK TAPER ACCORDING TO DIN 2080 SPECIFICATION.
2. EASY AND FAST CHANGING MILLING CHUCK (HOLDER).
3. CHUCK TAPER PRECISELY MACHINED SUITABLE FOR HEAVY CUTTING.

ORDER NO.	TAPER	SOCKET	A	C	WEIGHT KGS	CODE NO.
VD-101	NT30	NT30	144	70	1.3	3201-001
VD-102	NT40	NT30	150	70	2	3201-002
VD-103	NT40	NT40	181	89	2.4	3201-003
VD-105	NT50	NT40	175	89	3.8	3201-004
VD-106	R8	NT30	175	70	1.4	3201-005

MILLING-QUICK CHANGE SYSTEM KIT



ORDER NO.	TAPER	SOCKET	FULL SET	WEIGHT KGS	CODE NO.
VD-111	NT30	NT30	1. MILLING QUICK-CHANGE HOLDER 2. DRILL CHUCK HOLDER 3. MORSE TAPER HOLDER 4. FACE MILL HOLDER 5. DIN6388 #25 COLLET CHUCK HOLDER 6. DIN6388 #25 15PCS COLLET 7. WRENCH 8. WOODEN BOX	10	3201-006
VD-112	NT40	NT30		10.5	3201-007
VD-113	NT40	NT40		14	3201-008
VD-115	NT50	NT40		16	3201-009
VD-116	R8	NT30		10	3201-010



TG 100 Collet System

DIN 464E

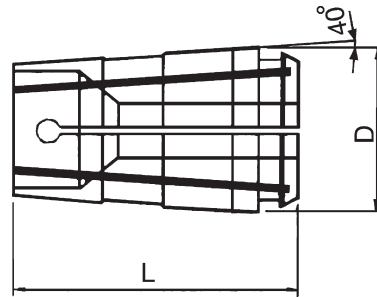

■ RANGE SIZE: 1/8"-63/64"

TG-100 ■ D:35 ■ L:61 ■ TAPER:4 ■ WEIGHT:0.2KGS

ORDER NO.	INCH	CODE NO.
TG10-01	1/8"	3204-001
TG10-02	3/16"	3204-002
TG10-03	1/4"	3204-003
TG10-04	5/16"	3204-004
TG10-05	3/8"	3204-005
TG10-06	7/16"	3204-006
TG10-07	1/2"	3204-007
TG10-08	9/16"	3204-008
TG10-09	5/8"	3204-009
TG10-10	11/16"	3204-010
TG10-11	3/4"	3204-011
TG10-12	13/16"	3204-012
TG10-13	7/8"	3204-013
TG10-14	15/16"	3204-014
TG10-15	1"	3204-015

ORDER NO.	INCH	CODE NO.
TG10-16	5/32"	3204-016
TG10-17	7/32"	3204-017
TG10-18	9/32"	3204-018
TG10-19	11/32"	3204-019
TG10-20	13/32"	3204-020
TG10-21	15/32"	3204-021
TG10-22	17/32"	3204-022
TG10-23	19/32"	3204-023
TG10-24	21/32"	3204-024
TG10-25	23/32"	3204-025
TG10-26	25/32"	3204-026
TG10-27	27/32"	3204-027
TG10-28	29/32"	3204-028
TG10-29	31/32"	3204-029

ORDER NO.	INCH	CODE NO.
TG10-30	9/64"	3204-030
TG10-31	11/64"	3204-031
TG10-32	13/64"	3204-032
TG10-33	15/64"	3204-033
TG10-34	17/64"	3204-034
TG10-35	19/64"	3204-035
TG10-36	21/64"	3204-036
TG10-37	23/64"	3204-037
TG10-38	25/64"	3204-038
TG10-39	27/64"	3204-039
TG10-40	29/64"	3204-040
TG10-41	31/64"	3204-041
TG10-42	33/64"	3204-042
TG10-43	35/64"	3204-043
TG10-44	37/64"	3204-044

ORDER NO.	INCH	CODE NO.
TG10-45	39/64"	3204-045
TG10-46	41/64"	3204-046
TG10-47	43/64"	3204-047
TG10-48	45/64"	3204-048
TG10-49	47/64"	3204-049
TG10-50	49/64"	3204-050
TG10-51	51/64"	3204-051
TG10-52	53/64"	3204-052
TG10-53	55/64"	3204-053
TG10-54	57/64"	3204-054
TG10-55	59/64"	3204-055
TG10-56	61/64"	3204-056
TG10-57	63/64"	3204-057



5C Collet System



5C RANGE

5C Collet

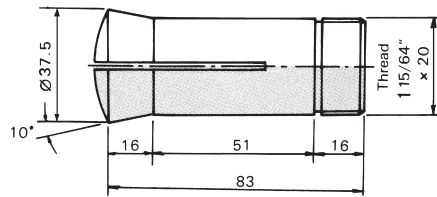

■ L:87 ■ D:37.5 ■ d:31.75
 ■ α:10° ■ WEIGHT:0.21KGS

ORDER NO.	Q'TY	RANGE SIZE
5C-□	1 PC	Ø3, 4, 5, 6, 7, 8, 9, 10, 11, 12, 13, 14, 15, 16, 17, 18, 19, 20, 21, 22, 23, 24, 25MM
5C-□	1 PC	Ø 1/8", 3/16", 1/4", 5/16", 3/8", 7/16", 1/2", 9/16", 5/8", 11/16", 3/4", 13/16", 7/8", 15/16", 1"

COMPLETE SET AVAILABLE SIZE

ORDER NO.	Q'TY	RANGE SIZE	PACKING	WEIGHT KGS	CODE NO.
VE-102	7PCS	6, 8, 10, 12, 16, 20, 25	CARTON	1.5	3205-100
VE-102I	7PCS	1/4", 5/16", 3/8", 1/2", 5/8", 3/4", 1"	CARTON	1.5	3205-101

EMERGENCY TYPE SOFT COLLET

ORDER NO.	MATERIAL	CODE NO.
VE-5CS	STEEL	3205-201
VE-5CB	BRASS	3205-202
VE-5CN	NYLON	3205-203

ORDER NO.	d	CODE NO.
5C-3	3	3205-001
5C-4	4	3205-002
5C-5	5	3205-003
5C-6	6	3205-004
5C-7	7	3205-005
5C-8	8	3205-006
5C-9	9	3205-007
5C-10	10	3205-008
5C-11	11	3205-009
5C-12	12	3205-010
5C-13	13	3205-011
5C-14	14	3205-012
5C-15	15	3205-013
5C-16	16	3205-014
5C-17	17	3205-015
5C-18	18	3205-016
5C-19	19	3205-017
5C-20	20	3205-018
5C-21	21	3205-019
5C-22	22	3205-020
5C-23	23	3205-021
5C-24	24	3205-022
5C-25	25	3205-023

ORDER NO.	d	CODE NO.
5C-1/8	1/8"	3205-024
5C-3/16	3/16"	3205-025
5C-1/4	1/4"	3205-026
5C-5/16	5/16"	3205-027
5C-3/8	3/8"	3205-028
5C-7/16	7/16"	3205-029
5C-1/2	1/2"	3205-030
5C-9/16	9/16"	3205-031
5C-5/8	5/8"	3205-032
5C-11/16	11/16"	3205-033
5C-3/4	3/4"	3205-034
5C-13/16	13/16"	3205-035
5C-7/8	7/8"	3205-036
5C-15/16	15/16"	3205-037
5C-1	1"	3205-038



R8 Collet System

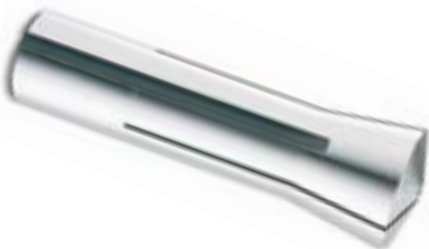

R8 Collet

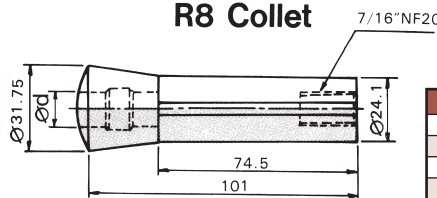

■ L:105 ■ D:31.75 ■ d:24.1
 ■ G:7/16-20UNF ■ α:8°30' ■ WEIGHT:0.21KGS

ORDER NO.	Q'TY	RANGE SIZE
R8-□	1 PC	Ø3, 4, 5, 6, 7, 8, 9, 10, 11, 12, 13, 14, 15, 16, 17, 18, 19, 20 MM
R8-□	1 PC	Ø 1/8", 3/16", 1/4", 5/16", 3/8", 7/16", 1/2", 9/16", 5/8", 11/16", 3/4"

COMPLETE SET AVAILABLE SIZE

ORDER NO.	Q'TY	RANGE SIZE	WEIGHT KGS	CODE NO.
VE-110	6 PCS	6, 8, 10, 12, 16, 20 MM	1.5	3206-100
VE-114	7 PCS	6, 8, 10, 12, 14, 16, 20 MM	1.5	3206-101

EMERGENCY TYPE SOFT COLLET

ORDER NO.	Q'TY	RANGE SIZE	WEIGHT KGS	CODE NO.
VE-109I	5 PCS	1/4", 3/8", 1/2", 5/8", 3/4"	1.1	3206-102
VE-110I	6 PCS	1/4", 5/16", 3/8", 1/2", 5/8", 3/4"	1.6	3206-103
VE-114I	7 PCS	3/16", 1/4", 5/16", 3/8", 1/2", 5/8", 3/4"	1.6	3206-104

ORDER NO.	d	CODE NO.
R8-3	3	3206-001
R8-4	4	3206-002
R8-5	5	3206-003
R8-6	6	3206-004
R8-7	7	3206-005
R8-8	8	3206-006
R8-9	9	3206-007
R8-10	10	3206-008
R8-11	11	3206-009
R8-12	12	3206-010
R8-13	13	3206-011
R8-14	14	3206-012
R8-15	15	3206-013
R8-16	16	3206-014
R8-17	17	3206-015
R8-18	18	3206-016
R8-19	19	3206-017
R8-20	20	3206-018

ORDER NO.	d	CODE NO.
R8-1/8	1/8"	3206-019
R8-3/16	3/16"	3206-020
R8-1/4	1/4"	3206-021
R8-5/16	5/16"	3206-022
R8-3/8	3/8"	3206-023
R8-7/16	7/16"	3206-024
R8-1/2	1/2"	3206-025
R8-9/16	9/16"	3206-026
R8-5/8	5/8"	3206-027
R8-11/16	11/16"	3206-028
R8-3/4	3/4"	3206-029



U2 Collet System



NO.1 U2 COLLET RANGE SIZE 3~16mm ■ L:120 ■ D:28 ■ d:20 ■ G:2.0P
 ■ α:17°30' ■ WEIGHT:0.18KGS

NO.1



ORDER NO.	Q' TY	RANGE SIZE
VE-U2-□	1 PC	NO.1 Ø 1, 1.5, 2, 3, 4, 5, 6, 7, 8, 9, 10, 11, 12, 13, 14, 15, 16 NO.2 Ø 18, 20, 25MM
VE-U2-□	1 PC	Ø 1/8", 3/16", 1/4", 5/16", 3/8", 1/2", 5/8"

NO.2 U2 COLLET RANGE SIZE 18~25mm

NO.2

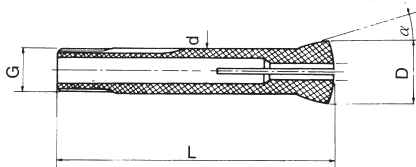

ORDER NO.	d	CODE NO.
VE-U2-1	1	3207-025
VE-U2-1.5	1.5	3207-026
VE-U2-2	2	3207-027
VE-U2-3	3	3207-001
VE-U2-4	4	3207-002
VE-U2-5	5	3207-003
VE-U2-6	6	3207-004
VE-U2-7	7	3207-005
VE-U2-8	8	3207-006
VE-U2-9	9	3207-007

ORDER NO.	d	CODE NO.
VE-U2-10	10	3207-008
VE-U2-11	11	3207-009
VE-U2-12	12	3207-010
VE-U2-13	13	3207-011
VE-U2-14	14	3207-012
VE-U2-15	15	3207-013
VE-U2-16	16	3207-014
VE-U2-18	18	3207-015
VE-U2-20	20	3207-016
VE-U2-25	25	3207-017

ORDER NO.	d	CODE NO.
VE-U2-1/8	1/8"	3207-018
VE-U2-3/16	3/16"	3207-019
VE-U2-1/4	1/4"	3207-020
VE-U2-5/16	5/16"	3207-021
VE-U2-3/8	3/8"	3207-022
VE-U2-1/2	1/2"	3207-023
VE-U2-5/8	5/8"	3207-024



MT2 Collet System

■ D:18 ■ L:72 ■ G:3/8"-16 WEIGHT:0.12KGS
 ■ G:10X1.5P

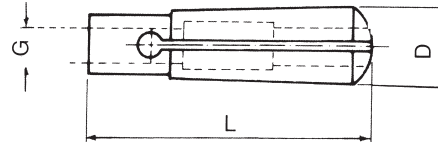

ORDER NO.	Q' TY	RANGE SIZE
MT2-□	1 PC	Ø 4, 6, 8, 10, 12MM
MT2-□	1 PC	Ø 1/8", 3/16", 1/4", 3/8", 1/2"

	d	CODE NO.
MT2-4	4	3208-001
MT2-6	6	3208-002
MT2-8	8	3208-003
MT2-10	10	3208-004
MT2-12	12	3208-005

ORDER NO.	d	CODE NO.
MT2-1/8	1/8"	3208-006
MT2-3/16	3/16"	3208-007
MT2-1/4	1/4"	3208-008
MT2-3/8	3/8"	3208-009
MT2-1/2	1/2"	3208-010



MT3 Collet System

■ D:24.1 ■ L:87 ■ WEIGHT:0.18KGS
 ■ DRAW BAR SIZE: G1.M12X1.75P
 G2.M10X1.5P
 G3.1/2"-12
 G4.3/8"-16



ORDER NO.	Q' TY	RANGE SIZE	DRAW BAR SIZE
MT3-□	1 PC	Ø 4, 6, 8, 10, 12, 16, 20MM	G1,G2
MT3-□	1 PC	Ø 1/8", 1/4", 3/8", 1/2", 5/8", 3/4"	G3,G4

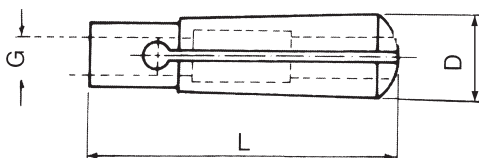

ORDER NO.	d	CODE NO.
MT3-4	4	3208-100
MT3-6	6	3208-101
MT3-8	8	3208-102
MT3-10	10	3208-103
MT3-12	12	3208-104
MT3-16	16	3208-105
MT3-20	20	3208-106

ORDER NO.	d	CODE NO.
MT3-1/8	1/8"	3208-107
MT3-1/4	1/4"	3208-108
MT3-3/8	3/8"	3208-109
MT3-1/2	1/2"	3208-110
MT3-5/8	5/8"	3208-111
MT3-3/4	3/4"	3208-112



Drill Chucks Arbor

R8

MT3.4.5

C20.25.32

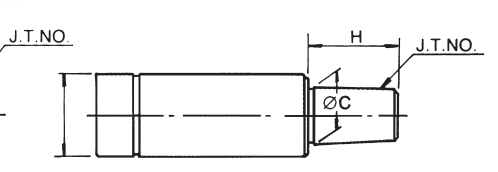
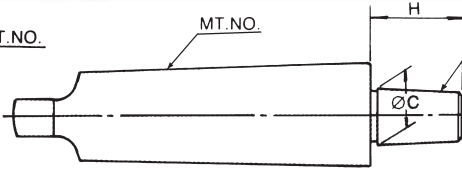
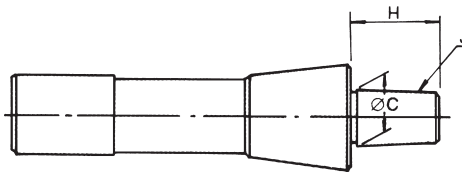

ORDER NO.	TAPER	JT NO.	C	H	WEIGHT (kg)	CODE NO.
VJ-121	R8	JT1	9.754	18	0.4	3209-001
VJ-122		JT2	13.94	20	0.43	3209-002
VJ-123		JT6	17.17	26	0.48	3209-003
VJ-124		B16	15.733	24	0.42	3209-004

ORDER NO.	TAPER	JT NO.	C	H	WEIGHT (kg)	CODE NO.
VJ-131	MT3	JT6	17.17	26	0.32	3209-030
VJ-132	MT4	JT6	17.17	26	0.6	3209-031
VJ-133	MT5	JT6	17.17	26	1.5	3209-032
VJ-134	MT3	B16	15.733	24	0.3	3209-033

ORDER NO.	TAPER	JT NO.	C	H	WEIGHT (kg)	CODE NO.
VJ-141	C20	JT6	17.17	26	0.2	3209-060
VJ-142	C25	JT6	17.17	26	0.3	3209-061
VJ-143	C32	JT6	17.17	26	0.5	3209-062



Morse Taper Sleeve

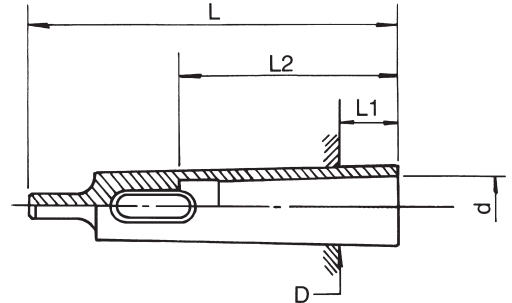

ORDER NO.	I.D.xO.D.	D	d	L	I1	I2	CODE NO.
VQ-101	MT2xMT3	23.825	17.780	112	18	67	0.2 3210-001
VQ-102	MT2xMT4	31.267	17.780	124	6.5	67	0.45 3210-002
VQ-103	MT2xMT5	44.399	17.780	156	6.5	67	1.3 3210-003
VQ-105	MT3xMT4	31.267	23.825	140	22.5	84	0.4 3210-005

ORDER NO.	I.D.xO.D.	D	d	L	I1	I2	GHT	CODE NO.
VQ-106	MT3xMT5	44.399	23.825	156	6.5	84	1.15	3210-006
VQ-107	MT3xMT6	63.348	23.825	218	8	84	4	3210-007
VQ-108	MT4xMT5	44.399	31.627	171	21.5	107	1	3210-008
VQ-109	MT4xMT6	63.348	31.627	218	8	107	3.6	3210-009
VQ-110	MT5xMT6	63.348	44.399	218	8	133	2.8	3210-010



R8 With Morse Taper Sleeve

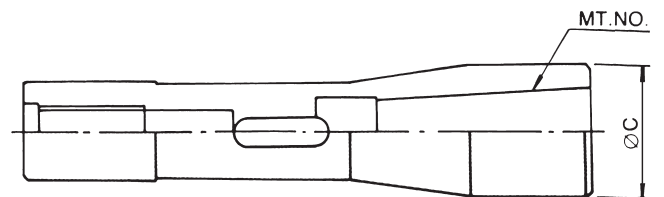

ORDER NO.	SHANK	SIZE	MT NO.	CODE NO.
VQ-122	R8	R8-MT2	MT2	0.3 3211-001
VQ-123	R8	R8-MT3	MT3	0.4 3211-002



Face Mill Arbor

DIN 2080/ISO SHANK

NT30, 40, 50, R8, MT3, 4

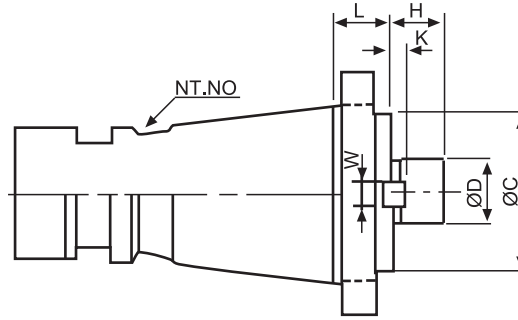

MATERIAL:SCM-21 HARDNESS:HRC 50°-55°

Squareness of mounting surface:Less than 0.0002"(0.005M/M)

Deflection in shaft and taper:Less than 0.0002"(0.005M/M)



NT40 WITH MAHO GAP



NT30

INCH FMA TYPE

ORDER NO.	TAPER	SHAFT SIZE				MOUNTING SIZE		WINGHT (kg)	CODE NO.
		D	H	W	K	C	L		
VF-101	NT30	25.4	20	9.57	5	65	20	0.72	3212-001
VF-102	NT30	31.75	23	12.75	7	73	20	0.75	3212-002
VF-103	NT30	38.1	22	15.90	9	82	20	2.10	3212-003
VF-104	NT40	25.4	20	9.57	5	65	20	1.45	3212-004
VF-105	NT40	31.75	22	12.75	7	73	20	1.75	3212-005
VF-106	NT40	38.1	23	15.90	9	82	20	2	3212-006
VF-109	NT50	25.4	20	9.57	5	65	20	3.3	3212-009
VF-110	NT50	31.75	22	12.75	7	73	20	3.4	3212-010
VF-111	NT50	38.1	23	15.90	9	82	20	3.6	3212-011
VF-112	NT50	50.8	24	19.05	10	95	20	3.9	3212-012
VF-114	R8	25.4	20	9.57	5	40	20	0.8	3212-014
VF-115	R8	31.75	22	12.75	7	53	20	1	3212-015
VF-116	MT-3	25.4	20	9.57	5	40	20		3212-016
VF-117	MT-4	25.4	20	9.57	5	40	20		3212-017

METRIC FMB TYPE

ORDER	TAPER	SHAFT SIZE				MOUNTING SIZE		WINGHT (kg)	CODE NO.
		D	H	W	K	C	L		
VF-120	NT30	22	18	9.57	5	40	20	0.6	3212-100
VF-121	NT30	27	20	12.75	7	53	20	0.7	3212-101
VF-122	NT30	32	23	15.90	7	63	20	0.9	3212-102
VF-123	NT40	22	18	9.57	5	40	20	1.2	3212-103
VF-124	NT40	27	20	12.75	7	53	20	1.35	3212-104
VF-125	NT40	32	23	15.90	7	63	20	1.41	3212-105
VF-126	NT40	40	26	19.05	8	85	20	1.82	3212-106
VF-127	NT40	60	32	25.40	5	128	24	3.8	3212-107
VF-128	NT50	22	18	9.57	5	40	20	3.2	3212-108
VF-129	NT50	27	20	12.75	7	53	20	3.3	3212-109
VF-130	NT50	32	23	15.90	7	63	20	3	3212-110
VF-131	NT50	40	26	19.05	8	85	20	3.6	3212-111
VF-132	NT50	60	32	25.40	5	128.57	24	5.5	3212-112
VF-134	R8	22	18	9.57	5	40	20	0.9	3212-113
VF-135	R8	27	20	12.75	7	53	20	0.95	3212-114
VF-136	MT-3	27	20	9.57	7	53	20	0.6	3212-115
VF-137	MT-4	27	20	9.57	7	53	20	1	3212-116

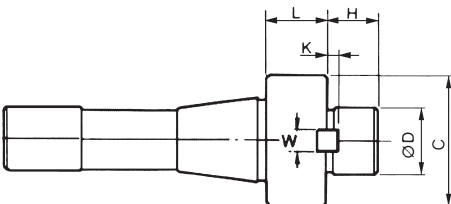
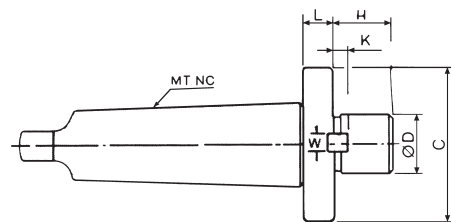



Morse Taper Adapter

DIN 2080/ISO SHANK

NT-30, 40, 50, R8, MT3, 4

MORSE TAPER ADAPTER WITH STRAIGHT SHANK

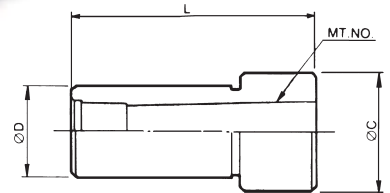
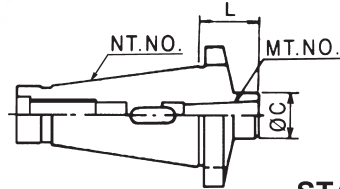

STANDARD TYPE

ORDER NO.	TAPER	TYPE	C	L	WEIGHT(kg)	CODE NO.
VI-101	NT30	MT1	25	25	0.57kg	3211-030
VI-102	NT30	MT2	32	50	0.57kg	3211-031
VI-103	NT30	MT3	35	65	0.58kg	3211-032
VI-104	NT40	MT1	25	30	0.87kg	3211-033
VI-105	NT40	MT2	32	30	0.87kg	3211-034
VI-106	NT40	MT3	40	70	1.2kg	3211-035
VI-107	NT40	MT4	50	90	1.48kg	3211-036
VI-108	NT50	MT2	32	30	3kg	3211-037
VI-109	NT50	MT3	40	30	3kg	3211-038
VI-110	NT50	MT4	50	45	3.4kg	3211-039
VI-111	NT50	MT5	65	105	3.7kg	3211-040

STANDARD TYPE

ORDER NO.	TAPER	SIZE	D	MT NO	C	L	WEIGHT(kg)	CODE NO.
VI-131	C20	C20-MT1	20	MT1	27	60	0.1	3211-060
VI-132	C20	C20-MT2	20	MT2	27	70	0.1	3211-061
VI-133	C25	C25-MT1	25	MT1	33	60	0.2	3211-062
VI-134	C25	C25-MT2	25	MT2	33	70	0.2	3211-063
VI-135	C25	C25-MT3	25	MT3	33	90	0.12	3211-064
VI-136	C32	C32-MT1	32	MT1	37	60	0.38	3211-065
VI-137	C32	C32-MT2	32	MT2	37	70	0.36	3211-066
VI-138	C32	C32-MT3	32	MT3	37	90	0.31	3211-067

PLEASE NOTIFY THE DRAW BAR THREAD SIZE WHEN ORDERING.



Jacobs Taper Drill Chuck Arbor

DIN 2080

NT30, 40, 50-JT & B

ISO SHANK

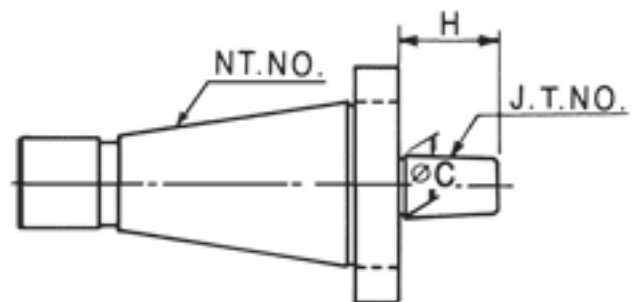

ORDER NO.	TAPER	JT NO	C	H	WEIGHT (kg)	CODE NO.
VJ-101	NT30	JT1	9.754	18	0.6	3209-090
VJ-102	NT30	JT2	13.94	20	0.6	3209-091
VJ-103	NT30	JT6	17.17	26	0.6	3209-092
VJ-105	NT40	JT2	13.94	20	1.2	3209-094
VJ-106	NT40	JT6	17.17	26	1.2	3209-095
VJ-109	NT50	JT6	17.17	26	3.5	3209-098
VJ-111	NT30	B16*	15.733	24	0.5	3209-099
VJ-112	NT40	B16*	15.733	24	1	3209-100
VJ-113	NT50	B16*	15.733	24	3.2	3209-101

PLEASE NOTIFY THE DRAW BAR THREAD SIZE WHEN ORDERING.



Sidelock END Mill Holder DIN 2080

NT30, 40, 50, R8-SLA

ISO SHANK

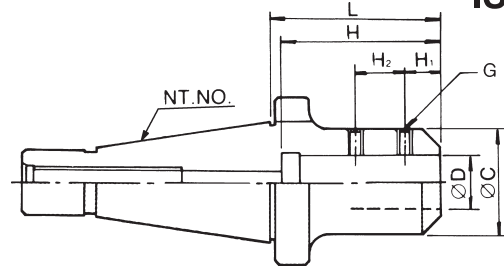

ORDER NO.	TAPER	D	C	H	L	H1	H2	G		CODE NO.
VN-101	NT30	12	40	45	55	20	16	M10	0.6	3213-001
VN-102	NT30	16	45	50	60	22	18	M10	0.7	3213-002
VN-103	NT30	20	50	60	65	25	20	M12	0.8	3213-003
VN-104	NT30	25	50	65	75	25	22	M12	1.0	3213-004
VN-105	NT40	12	40	45	55	20	16	M10	1.2	3213-005
VN-106	NT40	16	45	50	60	22	18	M10	1.3	3213-006
VN-107	NT40	20	50	60	65	25	20	M12	1.3	3213-007
VN-108	NT40	25	50	65	75	25	22	M12	1.5	3213-008
VN-109	NT40	32	60	70	90	30	22	M16	1.7	3213-009
VN-110	NT40	42	80	80	105	32	24	M16		3213-010
VN-111	NT50	12	40	45	55	20	16	M10	3	3213-011
VN-112	NT50	16	45	50	60	22	18	M10	3.1	3213-012
VN-113	NT50	20	50	60	65	25	20	M12	3.5	3213-013
VN-114	NT50	25	50	65	75	25	22	M12	3.5	3213-014
VN-115	NT50	32	60	70	90	30	22	M16	4	3213-015
VN-116	NT50	42	80	80	105	32	24	M16	4	3213-016
VN-117	NT50	50.8	95	90	105	35	25	M20	5	3213-017
VN-118	R8	12	40	45	55	20	16	M10	0.7	3213-018
VN-119	R8	16	20	50	60	22	18	M10	0.9	3213-019
VN-120	R8	20	50	60	65	25	20	M12		3213-020
VN-121	R8	20	50	65	75	25	22	M12		3213-021

Please notify the Draw Bar Thread Size When ordering.



Oil-Feed Holder / Slo

Coolant hole holder for straight shank
BT40, BT50

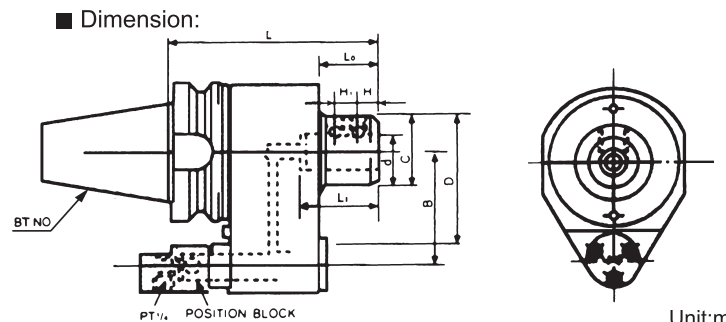

Unit:mm

ORDER NO.	d	L	B	C	D	L0	L1	H	H1	WEIGHT(kg)	CODE NO.
BT40SLO32-150	32	150	60(65)	53	90	52	60	15	15	4KGS	3214-001
BT40SLO40-150	40	150	60(65)	70	90	52	70	19	18	4.6KGS	3214-002
BT50SLO32-150	32	150	80(82)	54	100	42	60	15	15	7.1KGS	3214-003
BT50SLO40-150	40	150	80(82)	64	100	52	70	19	18	7.8KGS	3214-004

Reducing sleeve for oil feed holder.

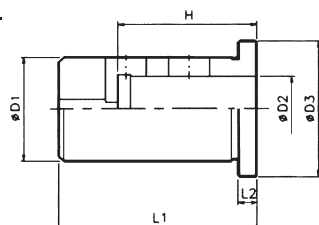

ORDER NO.	D1	D2	D3	L1	L2	H	WEIGHT(kg)	CODE NO.
OC32-20	32	20	42	63	6	48	0.4	3214-103
OC32-25		25				54	0.3	3214-104
OC40-25	40	25	50	63	6	54	0.6	3214-105
OC40-32		32				58	0.5	3214-106



Face Mill Arbor

BT-SHANK MAS 403

BT30,40,50



FIG. 1

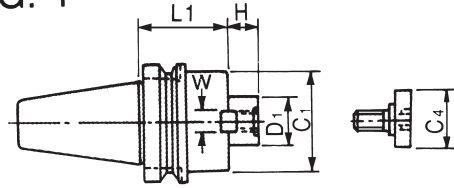
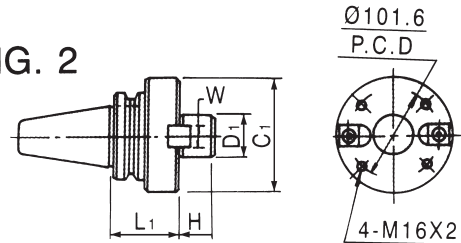

FIG. 2



INCH FMA TYPE

ORDER NO.	TAPER		D1	L1	H	C1	W	C4	WG (KG)	CODE NO.
BT-101	BT30	1	25.4	50	22	45	9.5	33	1.0	3212-201
BT-103	BT40	1	25.4	45	22	60	9.5	33	1.7	3212-203
BT-105	BT40	1	25.4	90	22	60	9.5	33	2.6	3212-205
BT-106	BT40	1	31.75	45	30	70	12.7	40	1.9	3212-206
BT-108	BT40	1	31.75	90	30	70	12.7	40	3.2	3212-208
BT-109	BT40	1	38.1	60	34	85	15.9	50	2.9	3212-209
BT-111	BT50	1	25.4	45	22	60	9.5	33	3.9	3212-211
BT-112	BT50	1	25.4	105	22	60	9.5	33	4.9	3212-212
BT-113	BT50	1	25.4	150	22	60	9.5	33	6.2	3212-213
BT-114	BT50	1	31.75	45	30	70	12.7	40	4.0	3212-214
BT-115	BT50	1	31.75	75	30	70	12.7	40	4.8	3212-215
BT-116	BT50	1	31.75	105	30	70	12.7	40	5.6	3212-216
BT-117	BT50	1	38.1	45	34	85	15.9	50	4.4	3212-217
BT-118	BT50	1	38.1	75	34	85	15.9	50	5.6	3212-218
BT-119	BT50	1	50.8	45	36	95	19.05	65	4.8	3212-219
BT-120	BT50	1	50.8	75	36	95	19.05	65	6.8	3212-220
BT-121	BT50	1	47.625	75	38	128.57	25.4	-	7.9	3212-221

METRIC FMB TYPE

ORDER NO.	TAPER	FIG	D1	L1	H	C1	W	C4	WG (KG)	CODE NO.
BT-150	BT30	1	22	45	18	48	10	33	2.0	3212-267
BT-151	BT30	1	27	45	20	60	12	33	2.2	3212-268
BT-152	BT40	1	22	45	18	48	10	50	2.5	3212-269
BT-153	BT40	1	22	90	18	48	10	33	2.3	3212-270
BT-154	BT40	1	27	45	20	60	12	33	2.5	3212-271
BT-155	BT40	1	27	90	20	60	12	33	4.7	3212-272
BT-156	BT40	1	32	45	22	62	14	50	2.7	3212-273
BT-157	BT40	1	40	60	26	85	16	50	7.4	3212-274
BT-158	BT50	1	22	45	18	60	10	33	3.8	3212-275
BT-159	BT50	1	22	75	18	60	10	33	3.5	3212-276
BT-160	BT50	1	27	45	20	70	12	33	4.0	3212-277
BT-161	BT50	1	27	75	20	60	12	33	5.8	3212-278
BT-162	BT50	1	27	150	20	60	12	33	8.2	3212-279
BT-163	BT50	1	32	75	22	75	14	50	4.2	3212-280
BT-164	BT50	1	32	105	22	80	14	33	3.0	3212-281
BT-165	BT50	1	32	150	22	80	14	33	4.0	3212-282
BT-166	BT50	1	40	75	26	85	16	50	6.1	3212-283



Face Mill Arbor

BT-SHANK MAS 403

BT30,40,50

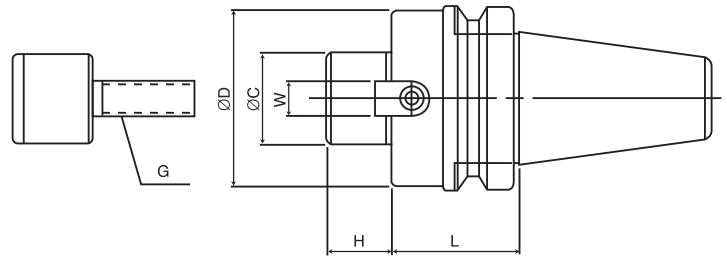

METRIC FMC TYPE

ORDER NO.	SIZE	øC	øD	L	H	W	G	WEIGHT (kg)	CODE NO.
BT-168	BT30-FMC22-45	22	48	45	18	10	M10x1.5P	0.85	3212-285
BT-169	BT40-FMC22-45	22	48	45	18	10	M10x1.5P	1.45	3212-286
BT-170	BT40-FMC22-90	22	48	90	18	10	M10x1.5P	2.20	3212-287
BT-171	BT40-FMC27-45	27	60	45	20	12	M12x1.75P	1.60	3212-288
BT-172	BT40-FMC27-90	27	60	90	20	12	M12x1.75P	2.30	3212-289
BT-173	BT40-FMC32-45	32	62	45	22	14	M16x2.0P	1.75	3212-290
BT-174	BT50-FMC22-45	22	60	45	18	10	M10x1.5P	4.50	3212-291
BT-175	BT50-FMC22-105	22	48	105	18	10	M10x1.5P	6.4	3212-292
BT-176	BT50-FMC22-150	22	48	150	18	10	M10x1.5P	6.8	3212-293
BT-177	BT50-FMC27-45	27	70	45	20	12	M12x1.75P	4.6	3212-294
BT-178	BT50-FMC27-105	27	60	105	20	12	M12x1.75P	6.7	3212-295
BT-179	BT50-FMC27-150	27	60	150	20	12	M12x1.75P	7.5	3212-296
BT-180A	BT50-FMC32-45	32	75	45	22	14	M16x2.0P	5.7	3212-297
BT-181A	BT50-FMC32-105	32	80	105	22	14	M16x2.0P	6.8	3212-298



Drill Chuck Holder/APU

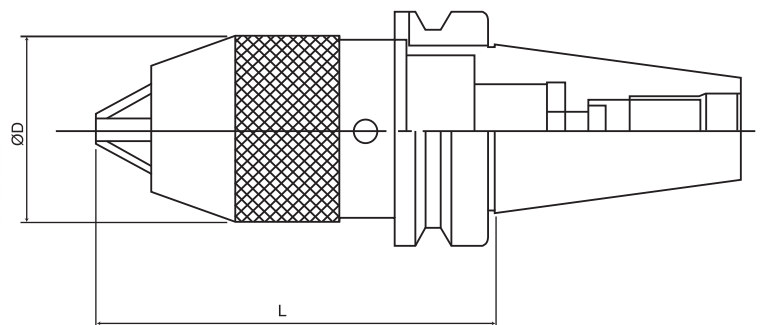

ORDER NO.	TAPER	øD	L		CODE NO.
BT-180	BT30-APU08-80	37	80	0.8	3212-301
BT-181	BT30-APU13-100	50	100	1	3212-302
BT-182	BT40-APU08-85	37	85	1.3	3212-303
BT-183	BT40-APU13-110	50	110	1.7	3212-304
BT-184	BT40-APU16-120	58	120	2.1	3212-305
BT-185	BT50-APU08-95	37	95	4	3212-306
BT-186	BT50-APU13-120	50	120	4.3	3212-307
BT-187	BT50-APU13-180	50	180	5.6	3212-308
BT-188	BT50-APU16-120	58	120	4.5	3212-309



Morse Taper Adaptor

MAS 403

BT30,40,50-MTA,MTB

BT-SHANK



MTA TYPE (STANDARD TYPE)

ORDER NO.	TAPER	MT.NO.	L1	C1	WEIGHT (KG)	CODE NO.
BT-204	BT30	MT-2	60	32	0.8	3211-091
BT-207	BT30	MT-3	90	40	1.2	3211-092
BT-209	BT40	MT-1	50	25	1.0	3211-094
BT-212	BT40	MT-2	50	32	1.0	3211-095
BT-215	BT40	MT-3	75	40	1.2	3211-096
BT-218	BT40	MT-4	95	50	1.4	3211-097
BT-220	BT50	MT-1	45	25	3.5	3211-098
BT-223	BT50	MT-2	50	32	3.5	3211-099
BT-226	BT50	MT-3	65	40	3.6	3211-100
BT-229	BT50	MT-4	75	50	3.6	3211-101
BT-231	BT50	MT-5	105	65	4.2	3211-102

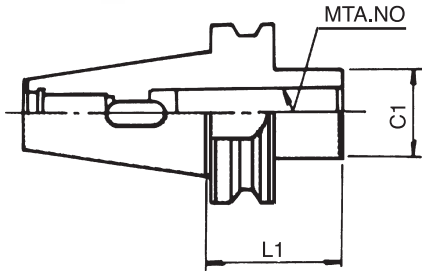

MTB TYPE

ORDER NO.	SIZE		L	ØD	G	HT (kg)	CODE NO.
BT-234	BT30-MTB1-45	MTB1	45	25	M6	0.7	3211-103
BT-235	BT30-MTB2-60	MTB2	60	32	M10	0.8	3211-104
BT-236	BT40-MTB1-45	MTB1	45	25	M6	1	3211-105
BT-237	BT40-MTB2-45	MTB2	45	32	M10	1	3211-106
BT-238	BT40-MTB3-75	MTB3	75	40	M12	1.2	3211-107
BT-239	BT40-MTB4-75	MTB4	75	48	M16	1.3	3211-108
BT-240	BT50-MTB1-45	MTB1	45	25	M6	3.5	3211-109
BT-241	BT50-MTB2-45	MTB2	45	32	M10	3.6	3211-110
BT-242	BT50-MTB3-60	MTB3	60	40	M12	3.7	3211-111
BT-243	BT50-MTB4-75	MTB4	75	48	M16	3.7	3211-112
BT-244	BT50-MTB5-120	MTB5	120	63	M20	5.2	3211-113

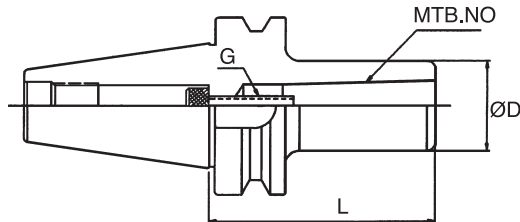

Jacobs Taper Arbor

MAS 403

BT30,40,50 JT & B

BT-SHANK

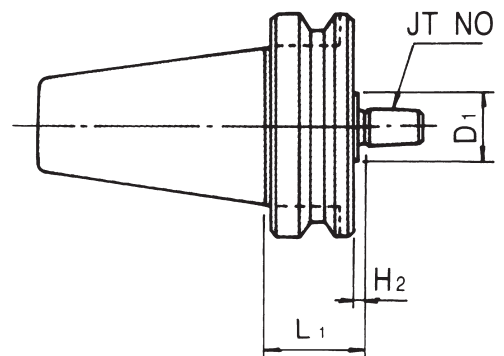

ORDER NO.	TAPER	JT.NO.	L1	D1	H2	WEIGHT (KG)	CODE NO.
BT-301	BT30	JT-1	45	30	3	0.6	3209-140
BT-307	BT30	JT-6	45	30	4	0.8	3209-142
BT-309	BT40	JT-1	45	30	3	1.3	3209-144
BT-313	BT40	JT-2	45	30	4	1.3	3209-145
BT-314	BT40	JT-2	90	30	4	1.4	3209-146
BT-315	BT40	JT-6	45	30	4	1.2	3209-147
BT-316	BT40	JT-6	90	30	4	1.4	3209-148
BT-325	BT50	JT-6	45	30	4	4.2	3209-151
BT-326	BT50	JT-6	105	30	4	4.6	3209-152
BT-332	BT40	B16*	45	30	4	1.45	3209-155
BT-333	BT50	B16*	45	30	4	5.1	3209-156



Sidelock End Mill Holder MAS 403

BT30,40,50-SLA



WELDON TYPE

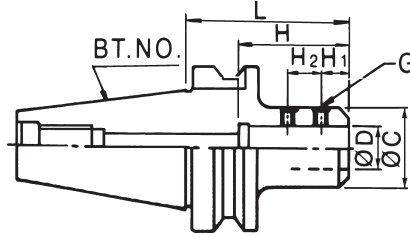

BT-SHANK

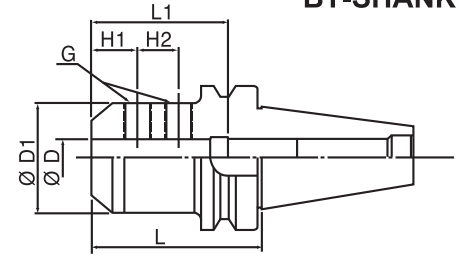

Unit:mm

ORDER NO.	SIZE	ØD	ØD1	L	L1	H1	H2	G	g)	CODE NO.
BT-436	BT30-SLA6-60	6	25	60	30	12	10	M6x1.0	0.65	3213-126
BT-437	BT30-SLA8-60	8	28	60	35	14	12	M8x1.25	0.65	3213-127
BT-438	BT30-SLA10-60	10	35	60	40	15	14	M8x1.25	0.7	3213-128
BT-439	BT30-SLA12-60	12	42	60	50	20	16	M12x1.5	0.7	3213-129
BT-440	BT30-SLA16-75	16	48	75	60	20	18	M12x1.5	0.8	3213-130
BT-441	BT30-SLA20-75	20	52	75	70	23	19	M12x1.5	0.8	3213-131
BT-442	BT40-SLA6-75	6	25	75	30	12	10	M6x1.0	1.1	3213-132
BT-443	BT40-SLA8-75	8	28	75	35	14	12	M8x1.25	1.2	3213-133
BT-444	BT40-SLA10-75	10	35	75	40	15	14	M8x1.25	1.3	3213-134
BT-445	BT40-SLA12-75	12	42	75	50	20	16	M12x1.5	1.4	3213-135
BT-446	BT40-SLA14-75	14	44	75	50	20	16	M12x1.5	1.4	3213-136
BT-447	BT40-SLA16-75	16	48	75	60	20	18	M12x1.5	1.5	3213-137
BT-448	BT40-SLA18-75	18	50	75	60	20	18	M12x1.5	1.5	3213-138
BT-449	BT40-SLA20-90	20	52	90	70	23	19	M12x1.5	1.8	3213-139
BT-450	BT40-SLA25-90	25	62	90	80	24	25	M18x1.5	2.1	3213-140
BT-451	BT40-SLA32-90	32	63	90	80	24	28	M20x1.5	2	3213-141
BT-452	BT40-SLA40-105	40	79	105	80	24	28	M20x1.5	2.9	3213-142
BT-453	BT40-SLA42-105	42	79	105	80	24	28	M20x1.5	2.9	3213-143
BT-454	BT50-SLA6-90	6	25	90	30	12	10	M6x1.0	3.7	3213-144
BT-455	BT50-SLA6-150	6	25	150	30	12	10	M6x1.0	4	3213-145
BT-456	BT50-SLA8-90	8	28	90	35	14	12	M8x1.25	3.7	3213-146
BT-457	BT50-SLA8-150	8	28	150	35	14	12	M8x1.25	4.15	3213-147
BT-458	BT50-SLA10-90	10	35	90	40	15	14	M8x1.25	3.9	3213-148
BT-459	BT50-SLA10-150	10	35	150	40	15	14	M8x1.25	4.3	3213-149
BT-460	BT50-SLA12-90	12	42	90	50	20	16	M12x1.5	3.9	3213-150
BT-461	BT50-SLA12-150	12	42	150	50	20	16	M12x1.5	4.6	3213-151
BT-462	BT50-SLA14-90	14	44	90	55	20	16	M12x1.5	3.9	3213-152
BT-463	BT50-SLA16-90	16	48	90	60	20	18	M12x1.5	4.1	3213-153
BT-464	BT50-SLA16-150	16	48	150	60	20	18	M12x1.5	5	3213-154
BT-465	BT50-SLA18-90	18	50	90	60	20	18	M12x1.5	4.1	3213-155
BT-466	BT50-SLA20-105	20	52	105	70	23	19	M12x1.5	4.8	3213-156
BT-467	BT50-SLA20-150	20	52	150	70	23	19	M12x1.5	5.2	3213-157
BT-468	BT50-SLA20-200	20	52	200	70	23	19	M12x1.5	6.1	3213-158
BT-469	BT50-SLA20-250	20	52	250	70	23	19	M12x1.5	7.1	3213-159
BT-470	BT50-SLA25-105	25	65	105	80	24	25	M18x1.5	5	3213-160
BT-471	BT50-SLA25-150	25	65	150	80	24	25	M18x1.5	6.1	3213-161
BT-472	BT50-SLA25-200	25	65	200	80	24	25	M18x1.5	7.3	3213-162
BT-473	BT50-SLA25-250	25	65	250	80	24	25	M18x1.5	9	3213-163
BT-474	BT50-SLA32-105	32	72	105	80	24	28	M20x1.5	5.1	3213-164
BT-475	BT50-SLA32-150	32	72	150	80	24	28	M20x1.5	6.5	3213-165
BT-476	BT50-SLA32-200	32	72	200	80	24	28	M20x1.5	8.1	3213-166
BT-477	BT50-SLA32-250	32	72	250	80	24	28	M20x1.5	9.8	3213-167
BT-478	BT50-SLA40-120	40	90	120	90	30	32	M20x1.5	6.5	3213-168
BT-479	BT50-SLA42-120	42	90	120	90	30	32	M20x1.5	6.5	3213-169



Pull Studs

BT30,40,50

FOR MAS 403

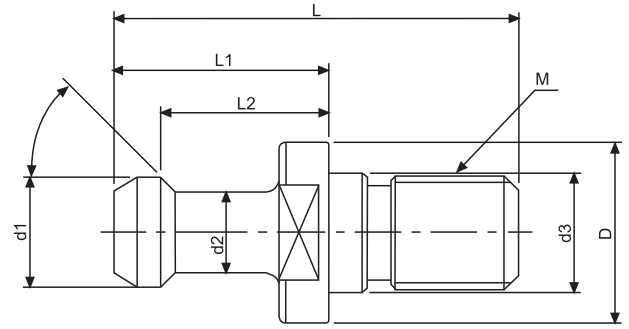

Unit:mm

ORDER NO.	TAPER NO.	a°	L	L1	L2	D	d1	d2	d3	M	CODE NO.
BT-510	BT30X90°	90	43	23	18	16.5	11	7	12.5	M12	3215-007
BT-501	BT30X45°	45	43	23	18	16.5	11	7	12.5	M12	3215-008
BT-502	BT30X60°	60	43	23	18	16.5	11	7	12.5	M12	3215-009
BT-511	BT40X90°	90	60	35	28	23	15	10	17	M16	3215-010
BT-503	BT40X45°	45	60	35	28	23	15	10	17	M16	3215-011
BT-504	BT40X60°	60	60	35	28	23	15	10	17	M16	3215-012
BT-512	BT50X90°	90	85	45	35	38	23	17	25	M24	3215-013
BT-505	BT50X45°	45	85	45	35	38	23	17	25	M24	3215-014
BT-506	BT50X60°	60	85	45	35	38	23	17	25	M24	3215-015

• With through hole for internal coolant



Pull Studs

MAS 403

FOR MAS 403

BT-40,50

• With through hole for internal coolant

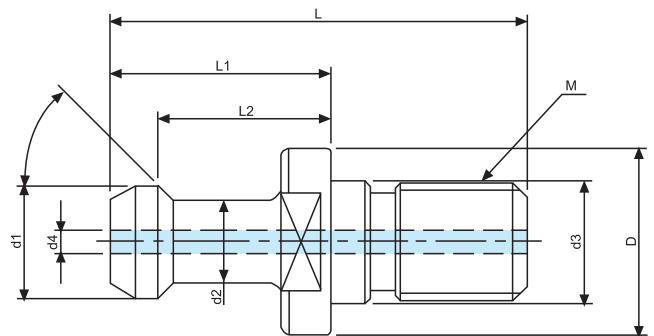

Unit:mm

ORDER NO.	TAPER NO.	a°	L	L1	L2	D	d1	d2	d3	d4	M	CODE NO.
BT-516	BT40X45°W	45	60	35	28	23	15	10	17	4	M16	3215-060
BT-517	BT40X60°W	60	60	35	28	23	15	10	17	4	M16	3215-061
BT-518	BT40X90°W	90	60	35	28	23	15	10	17	4	M16	3215-062
BT-519	BT50X45°W	45	85	45	35	38	23	17	25	7	M24	3215-063
BT-520	BT50X60°W	60	85	45	35	38	23	17	25	7	M24	3215-064
BT-521	BT50X90°W	90	85	45	35	38	23	17	25	7	M24	3215-065



Pull Studs

FOR DIN 69872

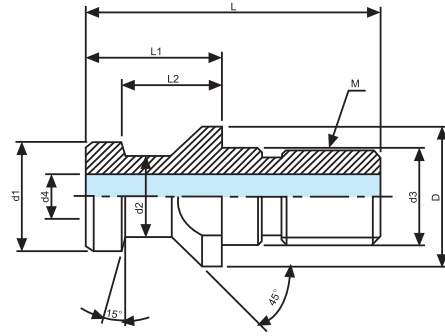

DIN 69872, (WITH THROUGH HOLE)-A TYPE

Unit:mm

ORDER NO.	TAPER NO.	L	L1	L2	D	d1	d2	d3	d4	M	CODE NO.
BT-522	DIN30-A	44	24	19	17	13	9	13		M12	3215-066
BT-523	DIN40-A	54	26	20	23	19	14	17	7	M16	3215-067
BT-524	DIN40-A-L	54	29	23	23	19	14	17	7	M16	3215-068
BT-525	DIN50-A	74	34	25	36	28	21	25	11.5	M24	3215-069

WITHOUT O-RING DIN 69872-B TYPE

Unit:mm

ORDER NO.	TAPER NO.	L	L1	L2	I3	I4	D	d1	d2	d3	d4	M	CODE NO.
BT-526	DIN30-B	44	24	19	1.4		17	13	9	13		M12	3215-070
BT-527	DIN40-B	54	26	20	1.9	27	23	19	14	17	7	M16	3215-071
BT-528	DIN50-B	74	34	25	3	37	36	28	21	25	11.5	M24	3215-072

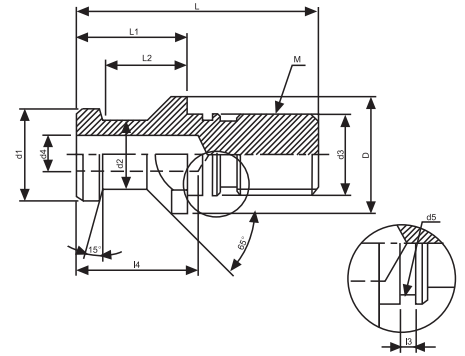

Pull Studs

ISO-A TYPE

FOR ISO/DIS 7388/2/A

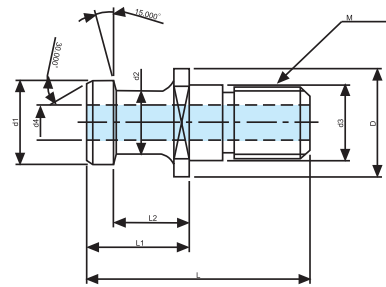

Unit:mm

ORDER NO.	TAPER NO.	L	L1	L2	D	d1	d2	d3	d4	M	CODE NO.
BT-529	ISO40-A	54	26	20	23	19	14	17	7	M16	3215-073
BT-530	ISO50-A	74	34	25	36	28	21	25	11.5	M24	3215-074

ISO-B TYPE

FOR ISO/DIS 7388/2/B

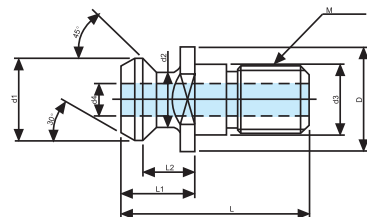

Unit:mm

ORDER NO.	TAPER NO.	L	L1	L2	D	d1	d2	d3	d4	M	CODE NO.
BT-531	ISO40-B	44.5	16.4	11.15	22.5	18.95	12.95	17	7.35	M16	3215-075
BT-532	ISO50-B	65.5	25.5	17.95	37	29.1	19.6	25	11.55	M24	3215-076



Pull Studs

MAZAK FOR MAZAK MACHINE



Unit:mm

ORDER NO.	TAPER NO.	L	L1	L2	L3	D	d1	d2	d3	d4	d5	M	CODE NO.
BT-533	MAZAK BT50	65.2	25.2	17.58	1.8	37	28.95	20.83	25	10	16	M24	3215-077
BT-534	MAZAK BT40	44.1	19.1	14		22	18.8	12.45	17	7		M16	3215-078
BT-535	MAZAK CAT40	41.1	16.1	11		22	18.8	12.45	17	7		M16	3215-079

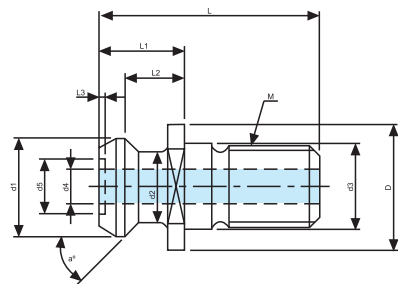

MITSUI FOR MITSUI MACHINE

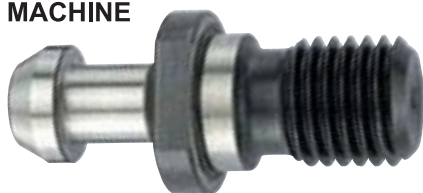

Unit:mm

ORDER NO.	TAPER NO.	a°	L	L1	L2	D	d1	d2	d3	M	CODE NO.
BT-536	MITSUI BT40	90	50	25	18	23	15	10	17	M16	3215-080
BT-537	MITSUI BT50	90	71	31	23	36	24	18	25	M24	3215-081

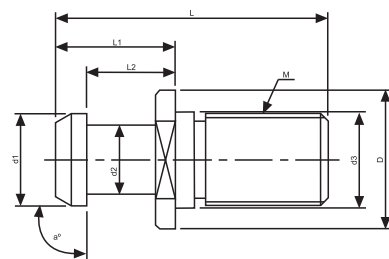

Pull Studs

CAT FOR ANSI B5-50



Unit:mm

ORDER NO.	TAPER NO.	a°	L	L1	L2	D	d1	d2	d4	M	CODE NO.
BT-538	CAT40	45	38.1	16.2	11.2	23.8	18.8	12.4	7.1	5/8"	3215-082
BT-539	CAT50	45	58.4	25.4	17.8	36	28.9	20.8	11.8	1"	3215-083

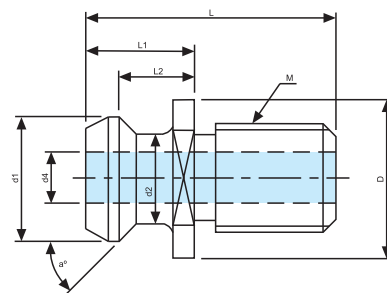

CAT-BT FOR BT MACHINE



Unit:mm

ORDER NO.	TAPER NO.	a°	L	L1	L2	D	d1	d2	d3	M	CODE NO.
BT-540	CAT40X45°	45	57	32	25	23	15	10		5/8"	3215-084
BT-541	CAT40X60°	60	57	32	25	23	15	10		5/8"	3215-085
BT-542	CAT40X90°	90	57	32	25	23	15	10		5/8"	3215-086
BT-543	CAT50X45°	45	78.6	45	35.2	38	23	17		1"	3215-087
BT-544	CAT50X60°	60	78.6	45	35.2	38	23	17		1"	3215-088
BT-545	CAT50X90°	90	78.6	45	35.2	38	23	17		1"	3215-089
BT-546	CAT40X45°M	45	57	32	25	23	15	10	17	M16	3215-090
BT-547	CAT40X60°M	60	57	32	25	23	15	10	17	M16	3215-091
BT-548	CAT40X90°M	90	57	32	25	23	15	10	17	M16	3215-092

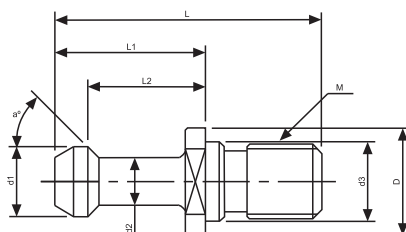



Complete NC Tooling Set

We recommend a complete set which is included tool holder, collet chuck, collet set, pull stud, tooling locking stand, edge finder for NC machining center. it is popular and suitable sale-mix in the market.



ORDER NO. VBT-30-0720

CODE NO. 3216-001

BT-30 WITH 7PCS. HOLDER & ER-20 COLLET

ITEM NO.	Descriptions	Figures	Quantity	Explanation
1	ER20 COLLET CHUCK BT30-ER20-60		3pcs.	For small Dia. End mill and Drills.
2	MORSE TAPER ADAPTOR BT30-MTA1-60		1pc.	For drills with Morse taper Shank No.1.
3	MORSE TAPER ADAPTOR BT30-MTA2-60		1pc.	For drills with Morse taper Shank No.2.
4	END MILL HOLDER BT30-SL12-60		1pc.	For straight shank end mill with Sidelock edge Dia. 12mm(WELDON Type)
5	END MILL HOLDER BT30-SL16-60		1pc.	For straight shank end mill with Sidelock edge Dia. 16mm(WELDON Type)
6	ER20 SPRING COLLET ER20-d \varnothing		11pcs.	For item 1. Including 11 collets as below: \varnothing 3,4,5,6,7,8,9,10,11,12,13mm
7	PULL STUD BT-501, BT-502		7pcs.	BT-501 $\theta = 45^\circ$ BT-502 $\theta = 60^\circ$
8	TOOL HOLDER LOCKING STAND VTS-BT-30		1pc.	For locking the pull studs or preparing Cutting tools of tool holders.
9	ELECTRONIC EDGE FINDER VPS-20B		1pc.	For setting work coordinate on Machine Centers.

ORDER NO. VBT-30-1520

CODE NO. 3216-011

BT-30 WITH 15PCS. HOLDER & ER-20 COLLET

ITEM NO.	Descriptions	Figures	Quantity	Explanation
1	ER20 COLLET CHUCK BT30-ER20-60		6pcs.	For small Dia. End mill and Drills.
2	MORSE TAPER ADAPTOR BT30-MTA1-60		1pc.	For drills with Morse taper Shank No.1.
3	MORSE TAPER ADAPTOR BT30-MTA2-60		1pc.	For drills with Morse taper Shank No.2.
4	FACE MILL ARBOR BT30-FMB22-45		1pc.	For holding the face milling Cutter Dia.50, 63mm
5	END MILL HOLDER BT30-SL12-60		2pcs.	For straight shank end mill with Sidelock edge Dia. 12mm(WELDON Type)
6	END MILL HOLDER BT30-SL16-60		2pcs.	For straight shank end mill with Sidelock edge Dia. 16mm(WELDON Type)
7	END MILL HOLDER BT30-SL20-75		2pcs.	For straight shank end mill with Sidelock edge Dia. 20mm(WELDON Type)
8	ER20 SPRING COLLET ER20-d \varnothing		11pcs.	For item 1. Including 11 collets as below: \varnothing 3,4,5,6,7,8,9,10,11,12,13mm
9	PULL STUD BT-501, BT-502		15pcs.	BT-501 $\theta = 45^\circ$ BT-502 $\theta = 60^\circ$
10	TOOL HOLDER LOCKING STAND VTS-BT-30		1pc.	For locking the pull studs or preparing Cutting tools of tool holders.
11	ELECTRONIC EDGE FINDER VPS-20B		1pc.	For setting work coordinate on Machine Centers.









Complete NC Tooling Set

We recommend a complete set which is included tool holder, collet chuck, collet set, pull stud, tooling locking stand, edge finder for NC machining center. it is popular and suitable sale-mix in the market

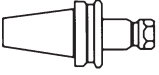
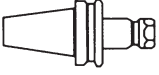
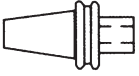
ORDER NO. VBT-40-1532

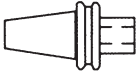
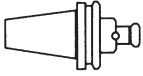
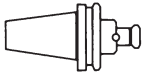
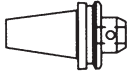
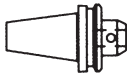
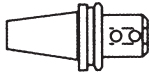
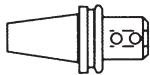
CODE NO. 3216-002

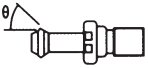
BT-40 WITH 15PCS. HOLDER & ER-32 COLLET

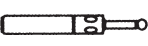
ITEM NO.	Descriptions	Figures	Quantity	Explanation
1	ER32 COLLET CHUCK BT40-ER32-70		3pcs.	For small Dia. End mill and Drills.
2	ER32 COLLET CHUCK BT40-ER32-100		3pcs.	For small Dia. End mill and Drills.
3	MORSE TAPER ADAPTOR BT40-MTA1-45		1pc.	For drills with Morse taper Shank No.1.
4	MORSE TAPER ADAPTOR BT40-MTA2-45		1pc.	For drills with Morse taper Shank No.2.
5	MORSE TAPER ADAPTOR BT40-MTA3-75		1pc.	For drills with Morse taper Shank No.3.
6	FACE MILL ARBOR BT40-FMB22-60		1pc.	For holding the face milling Cutter Dia.50, 63mm
7	FACE MILL ARBOR BT40-FMB27-60		1pc.	For holding the face milling Cutter Dia.80mm
8	END MILL HOLDER BT40-SL16-75		1pc.	For straight shank end mill with Sidelock edge Dia. 16mm(WELDON Type)
9	END MILL HOLDER BT40-SL20-75		1pc.	For straight shank end mill with Sidelock edge Dia. 20mm(WELDON Type)
10	END MILL HOLDER BT40-SL25-75		1pc.	For straight shank end mill with Sidelock edge Dia. 25mm(WELDON Type)
11	END MILL HOLDER BT40-SL32-90		1pc.	For straight shank end mill with Sidelock edge Dia. 32mm(WELDON Type)
12	ER32 SPRING COLLET ER32-d Ø		11pcs.	For item 1.2. Including 11 collets as below: Ø4,5,6,8,10,12,13,15,16,18,20mm
13	PULL STUD BT-503 OR BT-504		15pcs.	BT503 $\theta = 45^\circ$ BT504 $\theta = 60^\circ$
14	TOOL HOLDER LOCKING STAND VTS-BT-40		1pc.	For locking the pull studs or preparing Cutting tools of tool holders.
15	ELECTRONIC EDGE FINDER VPS-20B		1pc.	For setting work coordinate on Machine Centers.











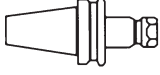
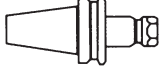

Complete NC Tooling Set

We recommend a complete set which is included tool holder, collet chuck, collet set, pull stud, tooling locking stand, edge finder for NC machining center. It is popular and suitable sale-mix in the market

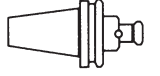
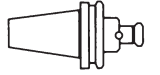
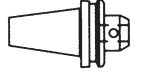
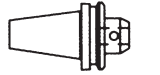
ORDER NO. VBT-40-2432

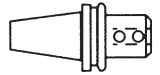
CODE NO. 3216-003

BT-40 WITH 23PCS. HOLDER & ER-32 COLLET

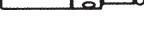
ITEM NO.	Descriptions	Figures	Quantity	Explanation
1	ER32 COLLET CHUCK BT40-ER32-70		4pcs.	For small Dia. End mill and Drills.
2	ER32 COLLET CHUCK BT40-ER32-100		4pcs.	For small Dia. End mill and Drills.
3	MORSE TAPER ADAPTOR BT40-MTA1-45		1pc.	For drills with Morse taper Shank No.1.
4	MORSE TAPER ADAPTOR BT40-MTA2-45		2pc.	For drills with Morse taper Shank No.2.
5	MORSE TAPER ADAPTOR BT40-MTA3-75		2pc.	For drills with Morse taper Shank No.3.
6	FACE MILL ARBOR BT40-FMB22-60		1pc.	For holding the face milling Cutter Dia.50, 63mm
7	FACE MILL ARBOR BT40-FMB27-60		1pc.	For holding the face milling Cutter Dia.80mm
8	END MILL ARBOR BT40-SL16-75		2pc.	For straight shank end mill with Sidelock edge Dia. 16mm(WELDON Type)
9	END MILL ARBOR BT40-SL20-75		2pc.	For straight shank end mill with Sidelock edge Dia. 20mm(WELDON Type)
10	END MILL ARBOR BT40-SL25-90		2pc.	For straight shank end mill with Sidelock edge Dia. 25mm(WELDON Type)
11	END MILL ARBOR BT40-SL32-90		2pc.	For straight shank end mill with Sidelock edge Dia. 32mm(WELDON Type)
12	ER32 SPRING COLLET ER32-d ∅		11pcs.	For item 1.2. Including 11 collets as below: ∅4,5,6,8,10,12,13,15,16,18,20mm
13	PULL STUD BT503 OR BT504		23pcs.	BT-503 $\theta = 45^\circ$ BT-504 $\theta = 60^\circ$
14	TOOL HOLDER LOCKING STAND VTS-BT-40		1pc.	For locking the pull studs or preparing Cutting tools of tool holders.
15	ELECTRONIC EDGE FINDER VPS-20B		1pc.	For setting work coordinate on Machine Centers.



Face Mill Holder

DIN 69871A

Holder For Face Mill Cutter.

DIN69871 A

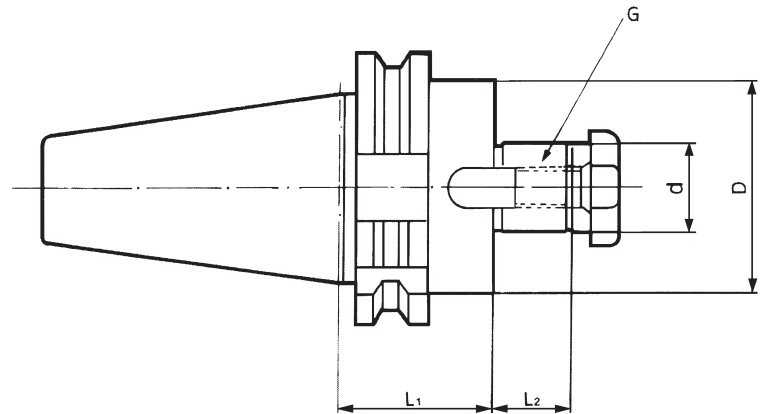

Unit:mm

ORDER NO.	SIZE	d	D	L1	L2	G		CODE NO.
SK-111	SK40-FM16-45	16	38	45	17	M8	1.2	3212-301
SK-112	SK40-FM22-45	22	48	45	18	M10	1.2	3212-302
SK-113	SK40-FM27-45	27	60	45	20	M12	1.6	3212-303
SK-114	SK40-FM32-45	32	62	45	22	M16	1.9	3212-304
SK-117	SK50-FM22-45	22	60	45	18	M10	3.4	3212-307
SK-118	SK50-FM27-45	27	70	45	20	M12	3.5	3212-308
SK-119	SK50-FM32-45	32	75	45	22	M16	3.7	3212-309
SK-120	SK50-FM40-55	40	85	55	26	M20	4.7	3212-310



Morse Taper Holder-DIN6383 DIN 69871A

Holder For Morse Taper Shank With Tang.
DIN69871 A

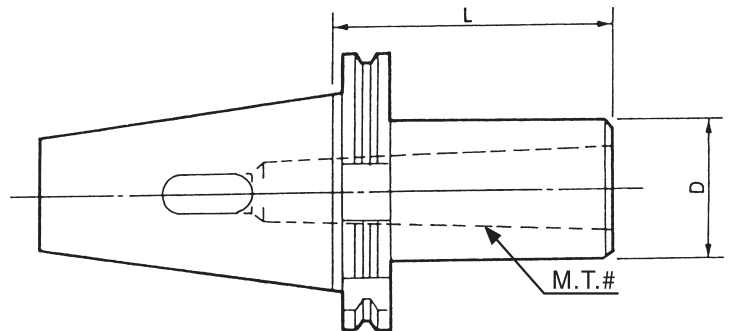

Unit:mm

ORDER NO.	SIZE	M.T.#	L	D	WEIGHT (kg)	CODE NO.
SK-211	SK30-MT1-50	1	50	25	0.7	3211-130
SK-212	SK30-MT2-65	2	65	32	0.7	3211-131
SK-213	SK30-MT3-80	3	80	40	0.8	3211-132
SK-214	SK40-MT1-45	1	45	25	1.2	3211-133
SK-215	SK40-MT2-50	2	50	32	1.1	3211-134
SK-216	SK40-MT3-70	3	70	40	1.2	3211-135
SK-217	SK40-MT4-90	4	90	48	1.35	3211-136
SK-218	SK50-MT1-45	1	45	25	3	3211-137
SK-219	SK50-MT2-60	2	60	32	3.1	3211-138
SK-220	SK50-MT3-65	3	65	40	3.3	3211-139
SK-221	SK50-MT4-90	4	90	48	3.5	3211-140
SK-222	SK50-MT5-105	5	105	63	3.7	3211-141



Sidelock END Mill Holder DIN 69871A

DIN69871 A

WELDON TYPE



■ Dimensions:

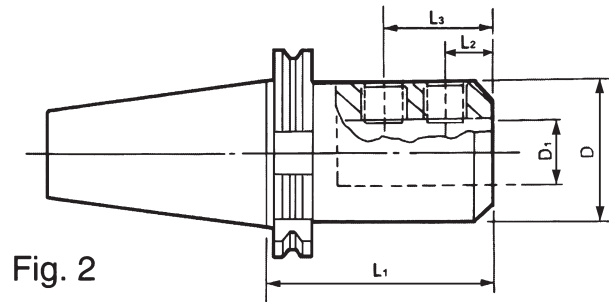
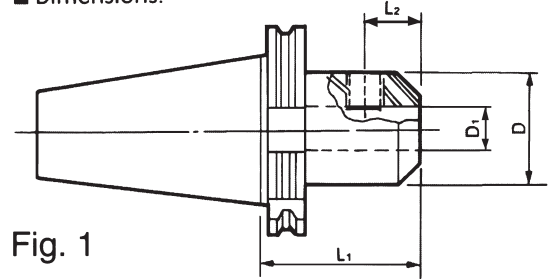

Unit:mm

ORDER NO.	SIZE	Fig.	D1	D	L1	L2	L3	g)	CODE NO.
SK-411	SK30-EM6-50	1	6	25	50	18	-	0.55	3213-201
SK-412	SK30-EM8-50	1	8	28	50	18	-	0.55	3213-202
SK-413	SK30-EM10-50	1	10	35	50	20	-	0.60	3213-203
SK-414	SK30-EM12-50	1	12	42	50	22.5	-	0.60	3213-204
SK-415	SK30-EM16-63	1	16	48	63	24	-	0.7	3213-205
SK-416	SK30-EM20-70	1	20	52	70	25	-	0.7	3213-206
SK-417	SK40-EM6-50	1	6	25	50	18	-	1.1	3213-207
SK-418	SK40-EM8-50	1	8	28	50	18	-	1.1	3213-208
SK-419	SK40-EM10-50	1	10	35	50	20	-	1.2	3213-209
SK-420	SK40-EM12-50	1	12	42	50	22.5	-	1.3	3213-210
SK-421	SK40-EM16-63	1	16	48	63	24	-	1.5	3213-211
SK-422	SK40-EM20-63	1	20	52	63	25	-	1.8	3213-212
SK-423	SK40-EM25-100	2	25	65	100	24	49	2.1	3213-213
SK-424	SK40-EM32-100	2	32	72	100	24	52	2.1	3213-214
SK-425	SK50-EM6-63	1	6	25	63	18	-	3.3	3213-215
SK-426	SK50-EM8-63	1	8	28	63	18	-	3.3	3213-216
SK-427	SK50-EM10-63	1	10	35	63	20	-	3.4	3213-217
SK-428	SK50-EM12-63	1	12	42	63	22.5	-	3.4	3213-218
SK-429	SK50-EM16-63	1	16	48	63	24	-	3.5	3213-219
SK-430	SK50-EM20-63	1	20	52	63	25	-	3.5	3213-220
SK-431	SK50-EM25-80	2	25	65	80	24	49	3.8	3213-221
SK-432	SK50-EM32-100	2	32	72	100	24	52	4.9	3213-222
SK-433	SK50-EM40-100	2	40	80	100	30	62	5	3213-223



Drill Chuck Holder / APU

DIN 69871A

DIN69871 A

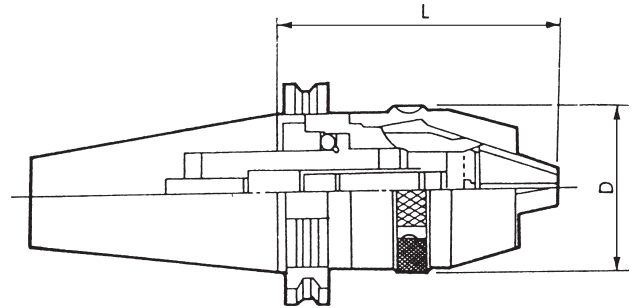

Unit:mm

ORDER NO.	SIZE	Clamping range (\varnothing mm)	D	L			CODE NO.
				Minimum	Maximum		
SK-511	SK40-APU08-80	1-8	36.3	80	86.5	1.3	3301-001
SK-512	SK40-APU13-105	1-13	51.5	105	109	1.7	3301-002
SK-513	SK50-APU08-80	1-8	36.3	80	97.5	3.8	3301-003
SK-514	SK50-APU13-105	1-13	51.5	105	120	4.1	3301-004
SK-509	SK30-APU08-70	0.5-8	36				3301-005
SK-510	SK30-APU13-82	0.5-13	50				3301-006



Drill Chuck Holder

DIN 69871A

DIN69871 A

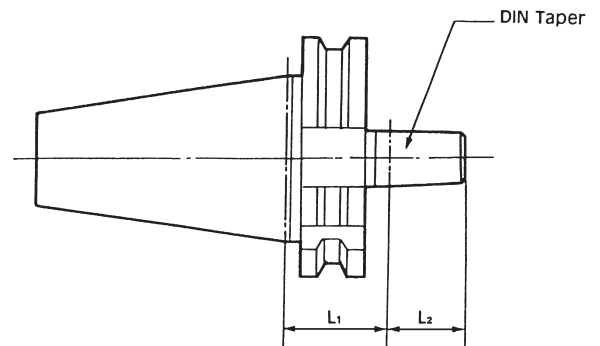

Unit:mm

ORDER NO.	SIZE	DIN Tper #	L1	L2		CODE NO.
SK-521	SK40-B16	B16	45	24	0.7	3209-180
SK-522	SK40-B18	B18	32	32	1	3209-181
SK-523	SK50-B16	B16	45	24	2.5	3209-182
SK-524	SK50-B18	B18	43	32	3	3209-183



HSK-A63(DIN-69893) Tool Holder

Form A

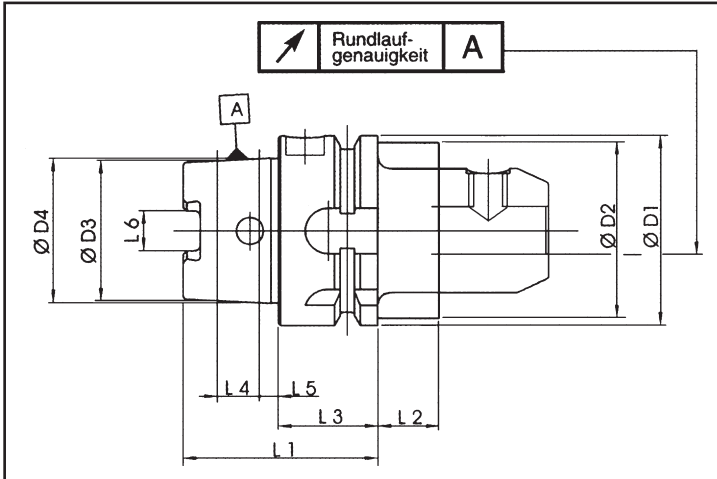

DIN 69893

Compared to the steep taper the HSK has the following advantages

- high repetition accuracy when clamping tools into spindle
- fix axial positioning by flat contact surface
- suitable for high speed cutting
- no pull stud necessary

Material

- special case-hardening steel for highly stressed parts
- surface hardness 58-2 HRC

Tensile strength in core min. 1000 N/mm²

SIZE	ØD1	ØD2	ØD3	ØD4	L1	L2	L3	L4	L5	L6
HSK 63	63	53	46.53	48	58	16	26	14.7	6.3	12.54

Collet chuck ER

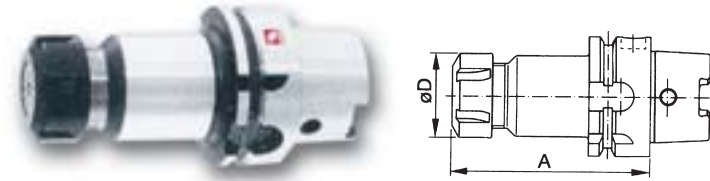

ORDER NO.	A	D ₂	WEIGHT (kg)	CODE NO.
A 63.020.ER16	100	28	1	3217-001
A 63.020.ER25	100	42	1.2	3217-002
A 63.020.ER32	100	50	1.4	3217-003
A 63.020.ER40	120	63	1.5	3217-004
A 63.022.ER16	160	28	1.7	3217-005
A 63.022.ER25	160	42	1.9	3217-006
A 63.022.ER32	160	50	2.1	3217-007
A 63.022.ER40	160	63	2.3	3217-008

Adapter for inserted tool milling cutter

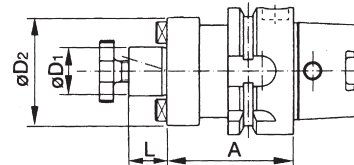

Weldon toolholder

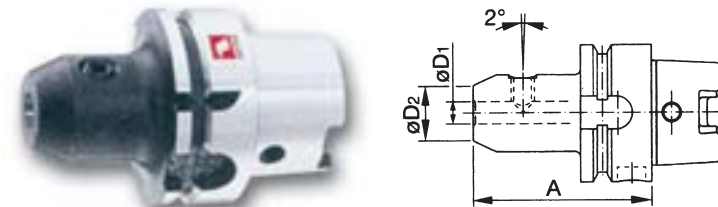

ORDER NO.	A	D ₂	WEIGHT (kg)	CODE NO.
A 63.030.SL6	80	25	1	3217-060
A 63.030.SL8	80	28	1.1	3217-061
A 63.030.SL10	80	35	1.1	3217-062
A 63.030.SL12	90	42	2	3217-063
A 63.030.SL14	90	44	2	3217-064
A 63.030.SL16	100	48	2	3217-065
A 63.030.SL18	100	50	2.1	3217-066
A 63.030.SL20	100	52	2.1	3217-067
A 63.030.SL25	110	65	2.6	3217-068
A 63.030.SL32	110	72	2.8	3217-069

ORDER NO.	A	D ₂	WEIGHT (kg)	CODE NO.
A 63.051.FMC22	100	50	1.3	3219-030
A 63.051.FMC27	100	60	1.5	3219-031
A 63.051.FMC32	100	78	1.6	3219-032
A 63.051.FMC40	100	87	2	3219-033
A 63.052.FMC22	160	50	1.5	3219-034
A 63.052.FMC27	160	60	1.7	3219-035
A 63.052.FMC32	160	78	1.8	3219-036
A 63.052.FMC40	160	87	2.2	3219-037

ACCURACY

CONCENTRIC $\leq 3\mu\text{m}(A < 160\text{mm})$

$\leq 4\mu\text{m}(A \geq 160\text{mm})$

HARDNESS HRC 56 ~ 58

TOOL DYNAMATIC BALANENCE TEST.



DC High Speed Slim Chuck System

5 μ
30,000
rpm

NEW

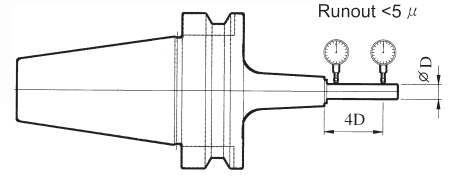

1. Smallest outside diameter in the world: $\phi 12$; this can solve the difficulties during thin processing on mold manufacture.
2. Collets with different sizes can be used on all kind of end mills, reamers, drills and tapping below 6m/m.
3. High speed balancing :30,000rpm; G2.5
4. Runout: $< 5 \mu$ m (Length 4D)



Slim Collet Chuck With Double Face Contact

5 μ
30,000
rpm

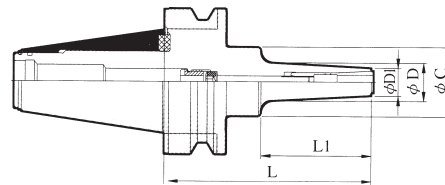

DC Collet System

1. For the features of double face contact.
2. Runout: below 0.005mm. (length 4D)
3. Smallest outside diameter in the world: $\phi 12$ (Collet inside diameter $\phi 1.75 \sim \phi 6$)
4. Max speed: 30,000rpm; G2.5.

R NO.		L	L1	D	D1	C	WEIGHT (kg)	CODE NO.
BTD30-DC6-60	BT30	60	38	16	12	—	0.8	3218-040
BTD30-DC6-90	BT30	90	50	17	12	30	0.9	3218-041
BTD40-DC6-60	BT40	60	33	16	12	—	1	3218-042
BTD40-DC6-90	BT40	90	48	17	12	30	1.2	3218-043



MAS BT30/40 Collet Chuck DC Collet System

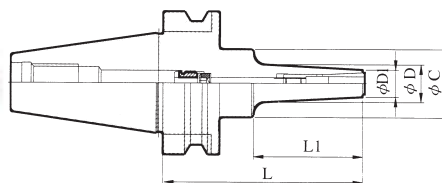

1. Runout: below 0.005mm. (length 4D)
2. Smallest outside diameter in the world : $\phi 12$ (Collet inside diameter $\phi 1.75 \sim \phi 6$)
3. Max speed :30,000rpm; G2.5.

	L	L1	D	D1	C	WEIGHT (kg)	DE NO.
BT30-DC6-60	60	38	16	12	—	0.8	3218-044
BT30-DC6-90	90	50	17	12	30	0.9	3218-045
BT40-DC6-60	60	33	16	12	—	1	3218-046
BT40-DC6-90	90	48	17	12	30	1.2	3218-047



Cylindrical Shank Of DC Slim Chuck

DC Collet System

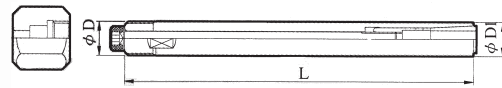

- 1.Runout:below 0.005mm.(length 4D)
- 2.Smallest outside diameter in the world:Ø12(Collet inside diameter $\phi 1.75 \sim \phi 6$)
- 3.Using anti-vibration material, surface hardness HRC 65°

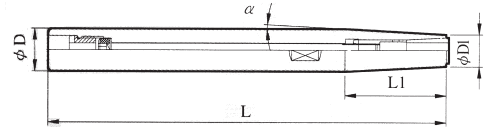

ORDER NO.	Fig	L	L1	D	D1		WEIGHT(kg)	CODE NO.
ST12-DC6-120	1	120	—	12	12	—	0.15	3218-048
ST16-DC6-150	2	150	38	16	12	3°	0.3	3218-049
ST20-DC6-200	2	200	76	20	12	3°	0.6	3218-050
ST25-DC6-250	2	250	124	25	12	3°	0.8	3218-051



Set Of DC Collets And Collet Chuck

DC Collet System



ORDER NO.	Collet Chuck	Collets	Spanner	Weight(kg)	
SST12-DC6-120E	ST12-DC6-120	EACH SET	30109-205	0.7	3218-052
SST16-DC6-150E	ST16-DC6-150	DC6-3E × 1pc	30109-205	0.7	3218-053
SST20-DC6-200E	ST20-DC6-200	DC6-4E × 1pc	30109-205	1	3218-054
SST25-DC6-250E	ST25-DC6-250	DC6-6E × 1pc	30109-205	1.3	3218-055



Small Collet Of Slim Collet Chuck

DC Collet System

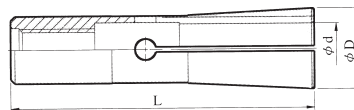

- 1.Below $\phi 6$ can clamp any shank.
- 2.DC6 series : for clamping drills, reamers and taps.
- 3.DC6-E series:for clamping end mills.
- 4.Runout : below 0.005mm. (length 4D)

ORDER NO.	Range(d)	WEIGHT (kg)	CODE NO.
DC6-2	1.75-2.00	0.05	3218-056
DC6-2.25	2.00-2.25	0.05	3218-057
DC6-2.5	2.25-2.50	0.05	3218-058
DC6-2.75	2.50-2.75	0.05	3218-059
DC6-3	2.75-3.00	0.05	3218-065
DC6-3.25	3.00-3.25	0.05	3218-066
DC6-3.5	3.25-3.50	0.05	3218-067
DC6-3.75	3.50-3.75	0.05	3218-068
DC6-4	3.75-4.00	0.05	3218-069

L	D	d
36	9.8	$\phi 2 \sim \phi 6$

ORDER NO.	Range(d)	WEIGHT(kg)	CODE NO.
DC6-4.25	4.00-4.25	0.05	3218-070
DC6-4.5	4.25-4.50	0.05	3218-071
DC6-4.75	4.50-4.75	0.05	3218-072
DC6-5	4.75-5.00	0.05	3218-073
DC6-5.25	5.00-5.25	0.05	3218-074
DC6-5.5	5.25-5.50	0.05	3218-075
DC6-5.75	5.50-5.75	0.05	3218-076
DC6-6	5.75-6.00	0.05	3218-077



For End Mill Shank

DC Collet System

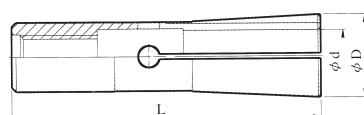

RDER NO.		g)	CODE NO.
DC6-3E	3	0.05	3218-078
DC6-4E	4	0.05	3218-079
DC6-5E	5	0.05	3218-080
DC6-6E	6	0.05	3218-081

L	D	d
36	9.6	$\phi 3 \sim \phi 6$



High Speed Chuck

UC COLLET CHUCK

For clamping HSC(High speed cutting) tools on machining centers.

Maximum speed:15,000 R.P.M

High accuracy:0.005mm T.I.R

Features

Taper of UC spring collet is 1/120, self-locked function makes high gripping power to prevent slip-out of the cutting tools.

UC spring collet chucks are made by high alloy steel and case hardened up to HRC59° and ground to ultra precision.

UC spring collets are slitted with a patented slotted-design for increasing gripping power and accuracy. (PAT.103654)

NEW



UC

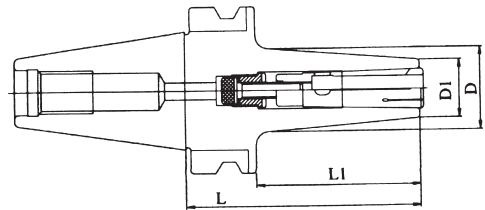

ORDER NO.	L		D	D1	Collets	GHT (kg)	CODE NO.
BT30-UC10-70	70	48	30	22	UC10	0.8	3218-001
BT40-UC10-90	90	63	32	22	UC10	1.4	3218-002
BT40-UC16-90	90	63	40	30	UC16	1.5	3218-003
BT50-UC10-110	110	72	36	22	UC10	4.9	3218-004
BT50-UC16-120	120	82	42	30	UC16	5	3218-005

STRAIGHT SHANK UC CHUCK

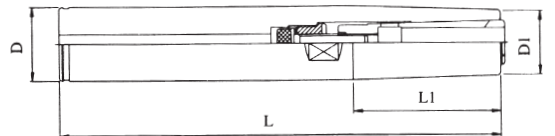

ORDER NO.	L	L1	D	D1	ets	WEIGHT (kg)	CODE NO.
C25-UC10-150	150	50	25	22	UC10	0.5	3218-030
C25-UC10-200	200	50	25	22	UC10	0.7	3218-031

UC SPRING COLLETS

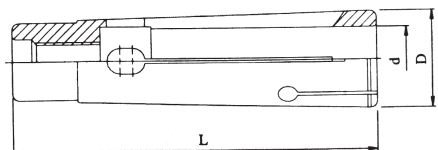

ORDER NO.	d		L	WEIGHT (kg)	CODE.NO.
UC10-6	6	15	56.5	0.054	3218-060
UC10-8	8			0.047	3218-061
UC10-10	10			0.039	3218-062

ORDER NO.	d	D		WEIGHT (kg)	CODE NO.
UC16-10	10	21	67	0.104	3218-090
UC16-12	12			0.104	3218-091
UC16-14	14			0.069	3218-092
UC16-16	16			0.089	3218-093



SD Collet Chuck

MAS BT 30/40/50

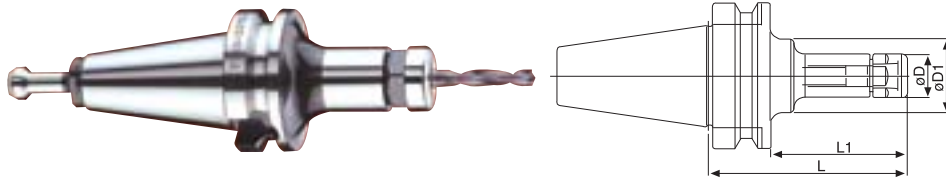

1. Without use any tools on insert collet into nut and take off collet from nut.
2. Max speed: 10,000rpm; G6.3.
3. SD collet designed with small angle 8° smaller than ER Collet 16°. Gripping Torque raises 2 times.
4. For special required, balance can reach 24,000rpm; G2.5.

ORDER NO.	Range	L	L1	D	D1	Nut	Wrench	Collet	CODE NO.
BT30-SD6-60	1.75~6.00	60	38	20	--	N-SD6	SDW-917	SD6 / SD6-E	3218-100
BT30-SD6-90	1.75~6.00	90	50	20	30	N-SD6	SDW-917	SD6 / SD6-E	3218-101
BT30-SD10-60	1.75~10.00	60	38	29	--	N-SD10	SDW-925	SD10 / SD10-E	3218-102
BT30-SD10-90	1.75~10.00	90	68	29	--	N-SD10	SDW-925	SD10 / SD10-E	3218-103
BT30-SD16-60	2.75~16.00	60	38	41	--	N-SD16	SDW-936	SD16 / SD16-E	3218-104
BT40-SD6-60	1.75~6.00	60	33	20	--	N-SD6	SDW-917	SD6 / SD6-E	3218-105
BT40-SD6-90	1.75~6.00	90	50	20	40	N-SD6	SDW-917	SD6 / SD6-E	3218-106
BT40-SD6-120	1.75~6.00	120	50	20	40	N-SD6	SDW-917	SD6 / SD6-E	3218-107
BT40-SD10-60	1.75~10.00	60	33	29	--	N-SD10	SDW-925	SD10 / SD10-E	3218-108
BT40-SD10-90	1.75~10.00	90	63	29	--	CN-SD10	SDW-925	SD10 / SD10-E	3218-109
BT40-SD10-120	1.75~10.00	120	70	29	40	N-SD10	SDW-925	SD10 / SD10-E	3218-110
BT40-SD10-150	1.75~10.00	150	88	29	40	N-SD10	SDW-925	SD10 / SD10-E	3218-111
BT40-SD16-60	2.75~16.00	60	33	41	--	N-SD16	SDW-936	SD16 / SD16-E	3218-112
BT40-SD16-90	2.75~16.00	90	63	41	--	N-SD16	SDW-936	SD16 / SD16-E	3218-113
BT40-SD16-120	2.75~16.00	120	93	41	--	N-SD16	SDW-936	SD16 / SD16-E	3218-114
BT40-SD16-150	2.75~16.00	150	123	41	--	N-SD16	SDW-936	SD16 / SD16-E	3218-115
BT40-SD20-60	4~20	60	33	50	--	N-SD20	SDW-702	SD20-E	3218-116
BT40-SD20-90	4~20	90	63	50	--	N-SD20	SDW-702	SD20-E	3218-117
BT40-SD20-120	4~20	120	93	50	--	N-SD20	SDW-702	SD20-E	3218-118
BT40-SD20-150	4~20	150	123	50	--	N-SD20	SDW-702	SD20-E	3218-119
BT40-SD25-80	6~25	80	53	55	--	N-SD25	SDW-703	SD25-E	3218-120
BT40-SD25-120	6~25	120	93	55	--	N-SD25	SDW-703	SD25-E	3218-121
BT50-SD6-100	1.75~6.00	100	50	20	40	N-SD6	SDW-917	SD6 / SD6-E	3218-122
BT50-SD6-150	1.75~6.00	150	50	20	40	N-SD6	SDW-917	SD6 / SD6-E	3218-123
BT50-SD10-100	1.75~10.00	100	62	29	--	N-SD10	SDW-925	SD10 / SD10-E	3218-124
BT50-SD10-150	1.75~10.00	150	70	29	50	N-SD10	SDW-925	SD10 / SD10-E	3218-125
BT50-SD16-100	2.75~16.00	100	62	41	--	N-SD16	SDW-936	SD16 / SD16-E	3218-126
BT50-SD16-150	2.75~16.00	150	112	41	--	N-SD16	SDW-936	SD16 / SD16-E	3218-127
BT50-SD20-100	4~20	100	62	50	--	N-SD20	SDW-702	SD20-E	3218-128
BT50-SD20-150	4~20	150	112	50	--	N-SD20	SDW-702	SD20-E	3218-129
BT50-SD20-200	4~20	200	162	50	--	N-SD20	SDW-702	SD20-E	3218-130
BT50-SD25-100	6~25	100	62	55	--	N-SD25	SDW-703	SD25-E	3218-131
BT50-SD25-150	6~25	150	112	55	--	N-SD25	SDW-703	SD25-E	3218-132
BT50-SD25-200	6~25	200	162	55	--	N-SD25	SDW-703	SD25-E	3218-133



SD Collet Chuck

DIN69871 SK40/50

ORDER NO.	Range	L1	L1	D	D1	Nut	Wrench	Collet	CODE NO.
SK40-SD6-80	1.75~6.00	80	53	20	40	N-SD6	SDW-917	SD6 / SD6-E	3218-140
SK40-SD10-80	1.75~10.00	80	53	29	--	N-SD10	SDW-925	SD10 / SD10-E	3218-141
SK40-SD16-80	2.75~16.00	80	53	41	--	N-SD16	SDW-936	SD16 / SD16-E	3218-142
SK40-SD20-80	4~20	80	53	50	--	N-SD20	SDW-702	SD20-E	3218-143
SK40-SD25-80	6~25	80	53	55	--	N-SD25	SDW-703	SD25-E	3218-144
SK50-SD6-100	1.75~6.00	100	80	20	50	N-SD6	SDW-917	SD6 / SD6-E	3218-145
SK50-SD10-100	1.75~10.00	100	80	29	--	N-SD10	SDW-925	SD10 / SD10-E	3218-146
SK50-SD16-100	2.75~16.00	100	80	41	--	N-SD16	SDW-936	SD16 / SD16-E	3218-147
SK50-SD20-100	4~20	100	80	50	--	N-SD20	SDW-702	SD20-E	3218-148
SK50-SD25-100	6~25	100	80	55	--	N-SD25	SDW-703	SD25-E	3218-149



SD Collet

1. Gripping range is 0.25mm for collets below 3mm. Collets larger than 3mm, the gripping range is 0.5mm.
2. Collets with 5 series, can grip drills, taps, reamers and end mills between 1.75mm-25mm.

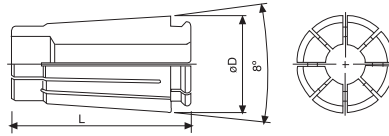

ORDER	D	L
SD6	10.55	25
SD10	15.60	30
SD16	24.6	45
SD20	30	50
SD25	35.6	57

COLLET LEVEL	RUNOUT
AA	3μ
A	7μ

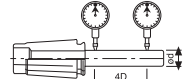

ORDER NO.	RANGE	CODE NO.
SD6-2	1.75-2	3218-160
SD6-2.25	2-2.25	3218-161
SD6-2.5	2.25-2.5	3218-162
SD6-2.75	2.5-2.75	3218-163
SD6-3	2.75-3	3218-164
SD6-3.5	3-3.5	3218-165
SD6-4	3.5-4	3218-166
SD6-4.5	4-4.5	3218-167
SD6-5	4.5-5	3218-168
SD6-5.5	5-5.5	3218-169
SD6-6	5.5-6	3218-170

ORDER NO.	RANGE	CODE NO.
SD10-2	1.75-2	3218-171
SD10-2.25	2-2.25	3218-172
SD10-2.5	2.25-2.5	3218-173
SD10-2.75	2.5-2.75	3218-174
SD10-3	2.75-3	3218-175
SD10-3.5	3-3.5	3218-176
SD10-4	3.5-4	3218-177
SD10-4.5	4-4.5	3218-178
SD10-5	4.5-5	3218-179
SD10-5.5	5-5.5	3218-180
SD10-6	5.5-6	3218-181

ORDER NO.	RANGE	CODE NO.
SD10-6.5	6-6.5	3218-182
SD10-7	6.5-7	3218-183
SD10-7.5	7-7.5	3218-184
SD10-8	7.5-8	3218-185
SD10-8.5	8-8.5	3218-186
SD10-9	8.5-9	3218-187
SD10-9.5	9-9.5	3218-188
SD10-10	9.5-10	3218-189

ORDER NO.	RANGE	CODE NO.
SD16-3	2.5-3	3218-190
SD16-3.5	3-3.5	3218-191
SD16-4	3.5-4	3218-192
SD16-4.5	4-4.5	3218-193
SD16-5	4.5-5	3218-194
SD16-5.5	5-5.5	3218-195
SD16-6	5.5-6	3218-196
SD16-6.5	6-6.5	3218-197
SD16-7	6.5-7	3218-198
SD16-7.5	7-7.5	3218-199
SD16-8	7.5-8	3218-200

ORDER NO.	RANGE	CODE NO.
SD16-8.5	8-8.5	3218-201
SD16-9	8.5-9	3218-202
SD16-9.5	9-9.5	3218-203
SD16-10	9.5-10	3218-204
SD16-10.5	10-10.5	3218-205
SD16-11	10.5-11	3218-206
SD16-11.5	11-11.5	3218-207
SD16-12	11.5-12	3218-208
SD16-12.5	12-12.5	3218-209
SD16-13	12.5-13	3218-210
SD16-13.5	13-13.5	3218-211

ORDER NO.	RANGE	CODE NO.
SD16-14	13.5-14	3218-212
SD16-14.5	14-14.5	3218-213
SD16-15	14.5-15	3218-214
SD16-15.5	15-15.5	3218-215
SD16-16	15.5-16	3218-216



ORDER NO.	COLLET	QUANTITY	CODE NO.
SSD6-11	Ø2-Ø6	11 pcs	3218-225
SSD10-19	Ø2-Ø10	19 pcs	3218-226
SSD16-27	Ø3-Ø16	27 pcs	3218-227



SD-E Collet (for end mill)



ORDER NO.	d	CODE NO.
SD6-3E	3	3218-230
SD6-4E	4	3218-231
SD6-6E	6	3218-232

ORDER NO.	d	CODE NO.
SD10-3E	3	3218-233
SD10-4E	4	3218-234
SD10-6E	6	3218-235
SD10-8E	8	3218-236
SD10-10E	10	3218-237

Gripping torque of SD-E Collets is 20% more than SD Collets. Can reach high stability during milling.

ORDER NO.	d	CODE NO.
SD16-3E	3	3218-238
SD16-4E	4	3218-239
SD16-6E	6	3218-240
SD16-8E	8	3218-241
SD16-10E	10	3218-242
SD16-12E	12	3218-243
SD16-16E	16	3218-244

ORDER NO.	d	CODE NO.
SD20-4E	4	3218-245
SD20-6E	6	3218-246
SD20-8E	8	3218-247
SD20-10E	10	3218-248
SD20-12E	12	3218-249
SD20-16E	16	3218-250
SD20-20E	20	3218-251

ORDER NO.	d	CODE NO.
SD25-6E	6	3218-252
SD25-8E	8	3218-253
SD25-10E	10	3218-254
SD25-12E	12	3218-255
SD25-16E	16	3218-256
SD25-20E	20	3218-257
SD25-25E	25	3218-258



ORDER NO.	COLLET	QUANTITY	CODE NO.
SSD10E-5	3, 4, 6, 8, 10	5 pcs	3218-270
SSD16E-7	3, 4, 6, 8, 10, 12, 16	7 pcs	3218-271
SSD20E-7	4, 6, 8, 10, 12, 16, 20	7 pcs	3218-272
SSD25E-7	6, 8, 10, 12, 16, 20, 25	7 pcs	3218-273



Stright Shank

SET OF SD COLLETS AND CHUCK / SD



Order NO.	Collet Chuck	Collet	Spanner	CODE NO.
SBC20-SD6-120	BC20-SD6-120	SD6-3E, 4E, 6E 3pcs	SDW-917	3218-280
SBC20-SD6-150	BC20-SD6-150	SD6-3E, 4E, 6E 3pcs	SDW-917	3218-281
SBC20-SD6-180	BC20-SD6-180	SD6-3E, 4E, 6E 3pcs	SDW-917	3218-282
SBC20-SD10-120	BC20-SD10-120	SD10-3E, 4E, 6E, 8E, 10E 5pcs	SDW-925	3218-283
SBC20-SD10-150	BC20-SD10-150	SD10-3E, 4E, 6E, 8E, 10E 5pcs	SDW-925	3218-284
SBC20-SD10-180	BC20-SD10-180	SD10-3E, 4E, 6E, 8E, 10E 5pcs	SDW-925	3218-285



Stright Shank SD Collet Chuck

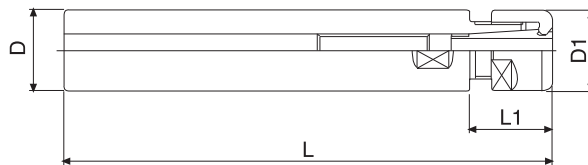

Order NO.	L	L1	D	D1	Collet	Wrench	
BC20-SD6-120	120	20	20	20	SD6-d	SDW-917	3218-290
BC20-SD6-150	150	20	20	20	SD6-d	SDW-917	3218-291
BC20-SD6-180	180	20	20	20	SD6-d	SDW-917	3218-292
BC20-SD10-120	120	38	20	29	SD10-d	SDW-925	3218-293
BC20-SD10-150	150	38	20	29	SD10-d	SDW-925	3218-294
BC20-SD10-180	180	38	20	29	SD10-d	SDW-925	3218-295



Clamping Nut



Fig.1



Fig.2

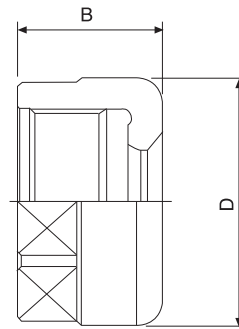

Fig.1

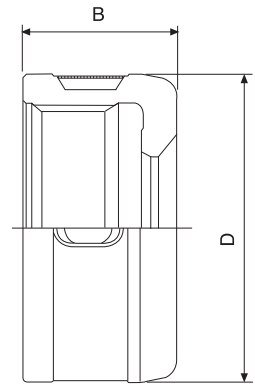

Fig.2

Order NO.	Fig	D	B	CODE NO.
N-SD6	1	20	1	3218-300
N-SD10	1	29	1	3218-301
N-SD16	1	41	2	3218-302
N-SD20	2	50	2	3218-303
N-SD25	2	55	2	3218-304



The Accessories For SD-Type Chuck

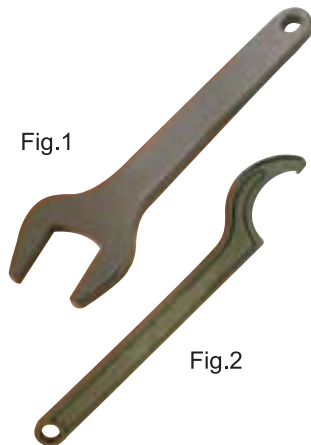
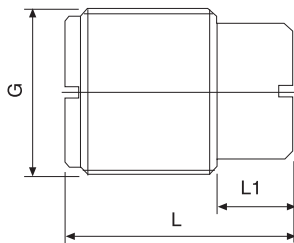

Fig.1

Fig.2

WRENCH

Order NO.	Fig	Type	CODE NO.
SDW-917	1	SP-SD6 / ER11	3218-310
SDW-925	1	SP-SD10 / ER16	3218-311
SDW-936	1	SP-SD16 / HEC12	3218-312
SDW-702	2	SP-SD20	3218-313
SDW-703	2	SD-SD25	3218-314



ADJUST SCREW

Order NO.	G	L	L1	Holder system	CODE NO.
AS-10	L-M12	25	10	SD10	3218-320
AS-16	L-M18	30	10	SD16	3218-321
AS-20	L-M22	30	10	SD20	3218-322
AS-25	L-M28	30	10	SD25	3218-323

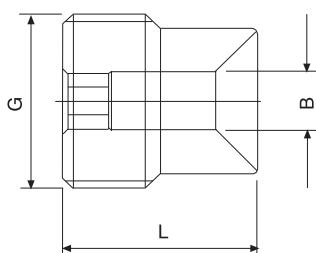

ADJUST SCREW WITH COOLANT HOLE

Order NO.	G	L	B	Holder system	CODE NO.
AS-10H	L-M12	20	3	SD10	3218-330
AS-16H	L-M18	20	4	SD16	3218-331
AS-20H	L-M22	24	4	SD20	3218-332
AS-25H	L-M28	30	4	SD25	3218-333



3D - TASTER



	TYPE	ACCURACY	CODE NO.
V - 3D	3D-Taster	0.01mm	3219-001

Find your exact zero points in all three axes in seconds with the new distance measuring scale (graduated and analogue).

1. Black scale for radial deflection.
2. Red scale for axial deflection
3. Precise and effortless calipering of fixtures and workpiece edges.
4. Setting of NC-programme zero points in seconds.
5. Measuring of clamped workpieces.
6. Generous overrun allowances prevent damage to Taster stylus.
7. Easy and precise change of stylus.

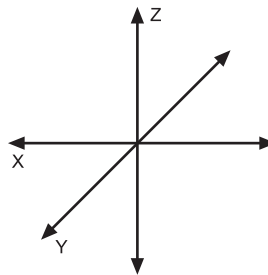

STYLUS

Change stylus in seconds

No screws or special tools required
Easy precision plug-in mechanism

ORDER NO.	TYPE	WEIGHT	CODE NO.
V-3D-05	ø4x33 standard stylus	10g	3219-005
V-3D-06	ø8x75 long stylus	15g	3219-006



Integrated Type Keyless Drill Chucks

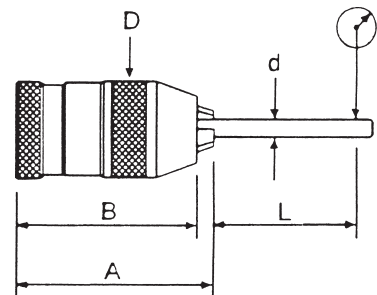

ORDER NO.	Clamping Capacity mm / inch	Tapper	OUTER Ø / mm	Weight (kg)	CODE NO.
INT-8-BT30	0.5-8 1/64"-1/8"	BT30	Ø35	0.7	3301-070
INT-13-BT30	0.5-13 1/64"-1/2"		Ø51.5	1.35	3301-071
INT-8-BT40	0.5-8 1/64"-1/8"	BT40	Ø51.5	1	3301-072
INT-8-CAT30	0.5-8 1/64"-1/8"	CAT30	Ø35	0.8	3301-073
INT-13-CAT30	0.5-13 1/64"-1/2"		Ø51.5	1	3301-074
INT-8-CAT40	0.5-8 1/64"-1/8"	CAT40	Ø35	1.32	3301-075
INT-13-CAT40	0.5-13 1/64"-1/2"		Ø51.5	2.1	3301-076
INT-16-CAT40	3-16 1/8"-5/8"		Ø58	2.26	3301-077
INT-13-CAT50	0.5-13 1/64"-1/2"	CAT50	Ø51.5	3.95	3301-078
INT-16-CAT50	3-16 1/8"-5/8"		Ø58	4.2	3301-079
INT-8-NT30	0.5-8 1/64"-1/8"	NT30	Ø51.5	0.65	3301-080
INT-8-NT40	0.5-8 1/64"-1/8"	NT40	Ø51.5	0.92	3301-081



Integrated Type Keyless Drill Chucks

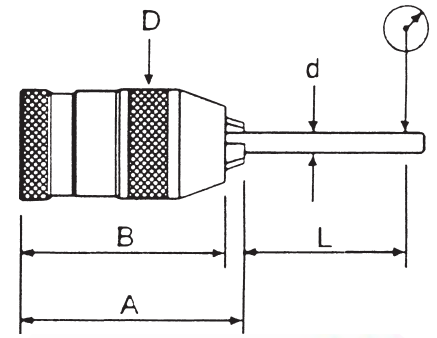

The main-shafts is of integrated type, which is much more superior than the traditional design.

The major features are as follows:

1. Extremely rigid construction.
2. The accumulative tolerances can be reduced to a minimum, since the traditional mechanism requiring an ARBOR to connect the Drill Chucks which will generate the accumulative tolerances.
The Integrated type Keyless Drill Chuck is designed to solve this problem totally.
3. Prevent the Drill Chucks from falling out.
4. Extremely safe in operation.

ITEM NO.	d mm	L mm	Max Tolerance mm	Torque kgf-cm
INT-8	3	35	0.05	160
	6			
	8	50		
INT-10	3	35	0.05	260
	6			
	10	55		
INT-13	5	75	0.05	400
	10			
	13	55		
INT-16	5	35	0.05	480
	10			
	16	80		

ORDER NO.	Clamping Capacity mm inch	Female Taper DIN or Jacobs	STD	OUTER Ø mm	Length		Weight (kg)	CODE NO.		
					open B mm	closed A mm				
INT-8-MT-2	0-8	MT-2		35	140	148	0.5	3301-030		
INT-8-JC-20	0-5/16"	JC-20			124	132	0.7	3301-031		
INT-13-R8	1-13 0-1/2"	R8		51.5	183	175	1.5	3301-032		
INT-13-MT3		MT-3			182	194	1.25	3301-033		
INT-13-MT4		MT-4			182	194	1.58	3301-034		
INT-13-JC-20		JC-20			138	150	1.1	3301-035		
INT-13-JC-25		JC-25			138	150	1.25	3301-036		
INT-13-JC-32		JC-32			138	150	1.45	3301-037		
INT-13-NT30		NT-30			138	150	1.5	3301-038		
INT-13-NT40		NT-40	DIN 2080		98	109	1.8	3301-039		
INT-13-BT40		BT-40	ISO		98	109	3.2	3301-040		
INT-13-BT50		BT-50	ISO		109	120	4.4	3301-041		
INT-13-NT50		NT-50						3001-059		
INT-16-R8		3-16 1/8"-5/8"	R8			58	188	202	1.85	3301-042
INT-16-MT3			MT3				188	202	1.52	3301-043
INT-16-MT4	MT4			188	202		1.85	3301-044		
INT-16-JC-20	JC-20			140	155		1.45	3301-045		
INT-16-JC-25	JC-25			150	165		1.5	3301-046		
INT-16-JC-32	JC-32			150	165		1.72	3301-047		
INT-16-NT30	NT-30			116	130		2	3301-048		
INT-16-NT40	NT-40		DIN 2080	116	130		2.2	3301-049		
INT-16-BT40	BT-40		ISO	116	130		4	3301-050		
INT-16-BT50	BT-50		ISO	126	140		4.8	3301-051		
INT-16-NT50	NT-50							3301-056		

Please notify Taper or Jacobs size when ordering.



Keyless Drill Chucks

**SPECIAL
HEAVY DUTY TYPE**

TYPE: XHSP



- Special design & manufacture against for super heavy torque (Clamping capacity) use.
- Owing to inspecting strictly & with excellent RUNOUT Accuracy and quality guanteed the gripping power is double than the general brand.
- Avoid the drill dropped when used in instaneous change of direction and equipped with spanner hole for tightening perfect safety.
- Especially suitable for CNC machining center & milling machine use.
- Accuracy: 50mm length within 0.05mm
- The key is optional

Unit:mm

ORDER NO.	Type	Clamping Capacity mm inch	Female Taper DIN or jacobcs	OUTER Ø mm	Length		Wt g	QTY Pcs./ Cu-Ft	N.W/G.W kge	CODE NO.
					open B mm	closed A mm				
11014	8XHSP	0-8 0-5 / 16"	J2	36	61	69	320	40/0.6	13/14	3302-001
11015			B10	36	61	69	320	40/0.6	13/14	3302-002
11016			J1	36	61	69	320	40/0.6	13/14	3302-003
11017			B12	36	61	69	320	40/0.6	13/14	3302-004
11018	10XHSP	0-10 0-3 / 8"	J33	43	81	92	700	40/0.6	28/29	3302-005
11019			J2S	43	81	92	700	40/0.6	28/29	3302-006
11020			B12	43	81	92	700	40/0.6	28/29	3302-007
11021			B16	43	81	92	700	40/0.6	28/29	3302-008
11025	13XHSP	0-13 0-1 / 2"	J6	51.5	92	103	1030	30/0.6	31/32	3302-009
11026			J33	51.5	92	103	1035	30/0.6	31/32	3302-010
11027			B16	51.5	92	103	1030	30/0.6	31/32	3302-011
11028	16XHSP	3-16 1-8 - 5/8"	J6	58	95	108	1450	24/0.6	35/36	3302-012
11029			B16	58	95	108	1450	24/0.6	35/36	3302-013
11030			B18	58	95	108	1450	24/0.6	35/36	3302-014
11035			J3	58	95	108	1450	24/0.6	35/36	3302-015
11031	Key	13XHSP								3304-001
11032		16XHSP								3304-002
11033		8XHSP								3304-003
11034		10XHSP								3304-004
17000	6XHSP	0.5-6.5 1/64"-1/4"	B12	34	61	69	320	8/0.6	26/27	3304-010
17002			J1	34	61	69	320	8/0.6	26/27	3304-011
17004			B10	34	61	69	320	8/0.6	26/27	3304-012



Keyless Drill Chucks

STANDARD TYPE

TYPE: H



- Industrial design especially for life and safety while in operation.
- All hardened parts ensure long milling machines and drilling machines.
- Accuracy: 35 m/m length within 0.08 m/m

Unit:mm

ORDER NO.	Type	Clamping Capacity mm inch	Female Taper DIN or jacobcs	OUTER Ø mm	Length		Wt g	CODE NO.
					open B mm	closed A mm		
11061	6H	0-6.5	J1	34	61	69	320	3302-030
11062		0-1 / 4"	B10	34	61	69	320	3302-031
11063	8H	0-8	J1	34	61	69	340	3302-032
11064		0-5 / 16"	B10	34	71	69	340	3302-033
11065	10H	0-10 0-3 / 8"	J2S	42.5	81	92	700	3302-034
11066			J33	42.5	81	92	700	3302-035
11067			B12	42.5	81	92	705	3302-036
11068			B16	42.5	81	92	705	3302-037
								3302-038
11070	13H	0-13 0-1 / 2"	J6	50.5	92	103	1030	3302-039
11071			J33	50.5	92	103	1035	3302-040
11072			B16	50.5	92	103	1030	3302-041
11073	16H	3-16 1-8 - 5/8"	J6	50.5	92	103	1030	3302-042
11074			B16	50.5	92	103	1030	3302-043
11075			B18	50.5	97	108	1040	3302-044



Keyless Drill Chucks HEAVY DUTY TYPE S

TYPE:S

Extremely high accuracy and precision design, suitable for CNC machines and machine center. All parts are ground, heat treated, surface treated and under specific QC condition.



ORDER NO.	Size	Capacity		Taper Mount No DIN or Jacobs	Length(m/m)		Outer Dia (m/m)	Weight (g)	CODE NO.
		mm	inch		Open	Closed			
12201-1	8S	0-8	0-5/16	JT1	68	76	38	420	3302-060
12201-2				JT2S	68	76	38	420	3302-061
12201-3				B10	68	76	38	420	3302-062
12201-4				B12	68	76	38	420	3302-063
12202-1	10S	0-10	0-3/8	JT2	80	92	43	640	3302-064
12202-2				JT33	80	92	43	640	3302-065
12202-3				B10	80	92	43	640	3302-066
12202-4				B12	80	92	43	640	3302-067
12203-1	13S	0-13	0-1/2	JT33	90	102	49	970	3302-068
12203-2				JT6	90	102	49	970	3302-069
12203-3				B12	90	102	49	970	3302-070
12203-4				B16	90	102	49	970	3302-071
12205-1	16S	3-16	1/8-5/8	JT6	97	110	55	1300	3302-073
12205-2				JT3	97	110	55	1300	3302-074
12205-3				B16	97	110	55	1300	3302-075
12205-4				B18	97	110	55	1300	3302-076



Keys



ORDER NO.	Type	Dmm	Lmm	Weight(g)	Packing	CODE NO.
14001	T1	3	35	20	Unpacked	3304-100
14002	T2	4	42	40	Unpacked	3304-101
14003	T3	5.5	44	45	Unpacked	3304-102
14004	T4	6	45	55	Unpacked	3304-103
14005	T5	6.5	45	50	Unpacked	3304-104
14006	T6	7	45	50	Unpacked	3304-105
14007	T7	8	50	80	Unpacked	3304-106
14008	T8	9.5	65	150	Unpacked	3304-107
14009	T9	11	100	320	Unpacked	3304-108
14010	P1	4	42	40	Unpacked	3304-109
14011	P2	5.5	44	45	Unpacked	3304-110
14012	P3	6	45	55	Unpacked	3304-111
14013	P4	6.5	45	50	Unpacked	3304-112
14014	P5	7	45	50	Unpacked	3304-113
14015	P6	8	50	80	Unpacked	3304-114
14016	P7	9.5	65	150	Unpacked	3304-115
14100	CK0	D(in) 1/8	300	20	Unpacked	3304-116
14101	CK1	5/32	361	25	Unpacked	3304-117
14102	CK2	1/4	-	-	Unpacked	3304-118
14103	CK3	5/16	55	80	Unpacked	3304-119
14104	CK4	3/8	74	180	Unpacked	3304-120
14105	CK30	15/64	43	40	Unpacked	3304-121
14106	CK32	1/4	50	60	Unpacked	3304-122
14107	KK	9/32	44	40	Unpacked	3304-123
14108	KG	1/4	35	25	Unpacked	3304-124



Key Type Drill Chucks

TYPE:G



- Representative products, super precision durable & rigity
- Big outside diameter suit for heary duty
- The nut and jaws adopt AISI-52100 (bearing steel) and heat-treated, durability the precision can be lssted.
- The taper is precision ground, advance the precision.
- Auuracy: 90mm length within 0.08mm

ORDER NO.	Type	Clamping Capacity mm inch	Female Taper DIN or jacobcs	OUTER \varnothing mm	Length		Wt g	Key Size	QTY Pcs./ Cu-Ft	N.W/G.W kgs	CODE NO.
					open B mm	closed A mm					
10006	G-6H	0.5-6.5	J1	32	40	50	200	CK3	100/0.82	20/21	3303-001
10007		1/64"-1/4"	B10	32	40	50	200	CK3	100/0.82	20/21	3303-002
10017	G-10XH	0.5-10	J2	41.5	50.5	64	390	CK4	60/0.85	24/25	3303-003
10018		1/64"-3/8"	J2S	41.5	50.5	64	390	CK4	60/0.85	24/25	3303-004
10050	G-13XH	0.5-13 1/64"-1/2"	J6	56	69	82	800	P6	36/0.83	30/31	3303-006
10051			B16	56	69	82	800	P6	36/0.83	30/31	3303-007
10052			J33	56	69	82	800	P6	36/0.83	30/31	3303-008
10068	G-16XH	1-16	J3	65	78	96	1000	P7	24/0.84	24/25	3303-009
10070		1/32"-5/8"	B18	65	78	96	1000	P7	24/0.84	24/25	3303-010
10074	G-19XH	3-19	J4	74	89	126	2150	P7	18/0.83	39/40	3303-011
10075		1/8"-3/4"	B22	74	89	126	2150	P7	18.0.83	39/40	3303-012



Ball Bearing Key Tpye Super Chucks

TYPE:H



- Suitable for heavy duty drilling use.
- By using anti-thrust bearing to increase the gripping power, so that, high speed drilling. can be performed
- All parts hardened by heat treatment and precision ground precision can be lasted, super clamping power.
- Accuracy:100m/m length is within 0.08m/m

ORDER NO.	Type	Clamping Capacity mm inch	Female Taper DIN or jacobcs	\varnothing mm	Length		Wt g	Key Size	CODE NO.
					open B mm	closed A mm			
12011	10BXH	1-10 1/32"-3/8"	J2S	45	56	64	390	P4	3303-030
12006	13BXH	1-13 1/32"-1/2"	J3	62	75	95	1200	P6	3303-031
12001			J6						
12002			J33						
12003	16BXH	1-16 1/32"5/8"	J3	65	81	101	1500	P7	3303-034
12004			B18						
12005	19BXH	1-19 1/32"-3/4"	J4	74	100	130	2150	P7	3303-036
12007	25BXH	5-25 3/16"-1"	J5	93	112	153	4100	T9	3303-037



Key Type Drill Chucks



- Suitable for use on heavy duty & extra heavy duty.
- For milling machine, lathe, drill machine & wood working machine.

ORDER NO.	Type	Clamping Capacity mm inch	Female Taper DIN or Jacobs	Female Thread Inch or metric	OUTER Ø mm	Length		Wt g	Key Size	CODE.NO.		
						open B mm	closed A mm					
10001	4H	0.5-4 1/64"-5/32"	JO		22	29	35	80	T1	3303-060		
10002B	5HB	0.5-6	5D		27.5	33	43	100	T2A	3303-061		
10003	6H	0.5-6.5 1/64"-1/4"	J1	3/8-24	32	40	50	190	T2	3303-062		
10004			B10	3/8-24	32	40	50	190	T2	3303-063		
10005			Ø 5.5x90°	3/8-24	32	40	50	190	T2	3303-064		
10010			J2	3/8-24 1/2-20	38	50.5	64	290	T3	3303-065		
10011	10H	1-10 1/32"-3/8"	J2S	3/8-24 1/2-20	38	50.5	64	290	T3	3303-066		
10012			B12	3/8-24 1/2-20	38	50.5	64	290	T3	3303-067		
10014			Ø 5.5x90°	3/8-24 1/2-20	38	50.5	64	290	T3	3303-068		
10015			Ø 6.5x90°	3/8-24 1/2-20	38	50.5	64	290	T3	3303-069		
10016			J1	3/8-24 1/2-20	38	50.5	64	290	T3	3303-070		
10038			13H	1-13 1/32"-1/2"	J2S	3/8-24 1/2-20	47	65	81	520	T5	3303-071
10039					J6	3/8-24 1/2-20	47	65	81	520	T5	3303-072
10040	B16	3/8-24 1/2-20			47	65	81	520	T5	3303-073		
10041	J33	3/8-24 1/2-20			47	65	81	520	T5	3303-074		
10042	Ø 5.5x90°	3/8-24 1/2-20			47	65	81	520	T5	3303-075		
10043	Ø 6.5x90°	3/8-24 1/2-20			47	65	81	520	T5	3303-076		
10061	16H	1-16 1/32"-5/8"	J6	1/2-20 5/8-16	56	78	96	800	T7	3303-077		
10062			J3	1/2-20 5/8-16	56	78	96	800	T7	3303-078		
10063			B16	1/2-20 5/8-16	56	78	96	800	T7	3303-079		
10064			B18	1/2-20 5/8-16	56	78	96	800	T7	3303-080		
10065			Ø 6.5x90°	1/2-20 5/8-16	56	78	96	800	T7	3303-081		
10066			Ø x90°	1/2-20 5/8-16	56	78	96	800	T7	3303-082		
10072			19H	3-19 1/8"-3/4"	B22		67.5	89	126	1570	T8	3303-083
10073	J3				67.5	89	126	1570	T8	3303-084		
10045	13XH	1-13 1/32"-1/2"	Ø 6.5x90°	1/2-20	52	69	82	770	T7	3303-085		
10046			J6	1/2-20	52	69	82	770	T7	3303-086		
10047			B16	1/2-20	52	69	82	770	T7	3303-087		
10048			J33	1/2-20	52	69	82	770	T7	3303-088		
10079	19XH	1-19	J4		69	94	132	1700	T8	3303-089		

Material Analysis Table

PART NO.	PART NAME	MATERIAL	HEAT TREATED
1	Body	JIS-4051 SAE 1045	HRC45-48
2	Case	JIS-4018 SAE0 1018	HRC38-40
3	Jaw	JIS-4051 SAE 1045	HRC52±2
4	Nut	JIS-4051 SAE 1045	HRC61±2

Run-out Accuracy & Torque Inspection Table

Type	4H	5H	6.5H	10H	13H	16H	19H	13XH	19XH
Ø dmm	3.5	4.5	6	9	12	15	18	12	18
Lmm	60	80	90	110	140	150	150	140	150
L1mm	40	60	70	85	110	120	120	110	120
Max Run-out	0.15	0.15	0.15	0.15	0.15	0.15	0.15	0.15	0.15
Torque kg-m	18	20	45	75	85	250	300	190	300



Key Type Drill Chucks



13H.S



13XH.S
COLLAR



H



XH

U.S.A. Market Style

- Suitable for use on heavy duty & extra heavy duty.
- For milling machine, lathe, drill machine & wood working machine.

ORDER NO.	Type	Clamping Capacity mm inch	Female Taper DIN or Jacobs	Female Thread Inch or metric	OUTER Ø mm	Length		Wt g	Key Size	CODE NO.
						open B mm	closed A mm			
19001	4H	0.5-4 1/64"-5/32"	JO		22	29	35	80	CK0	3303-100
19003	6H	0.5-6.5 1/64"-1/4"	J1		32	40	50	190	CK1	3303-101
19005			Ø 5.5x90°	3/8-24	32	40	50	190	CK1	3303-102
19010	10H	1-10 1/32"-3/8"	J2		37.8	51	64	260	CK30	3303-103
19011			J2S		37.8	51	64	290	CK30	3303-104
19014			Ø 5.5x90°	3/8-24	37.8	51	64	290	CK30	3303-105
19015			Ø 6.5x90°	1/2-20	37.8	51	64	290	CK30	3303-106
19016			J1		37.8	51	64	290	CK30	3303-107
19038			J2S		46	65	82	520	CK32	3303-108
19039	J6		46	65	82	520	CK32	3303-109		
19041	13H	1-13 1/32"-1/2"	J33		46	65	82	520	CK32	3303-110
19042			Ø 5.5x90°	3/8-24	46	65	82	520	CK32	3303-111
19043			Ø 6.5x90°	1/2-20	46	65	82	520	CK32	3303-112
19044				1/2-20	46	65	82	520	CK32	3303-113
19046			13HS	S- Ø 5/8	5/8"		46	78	95	610
19061	16H	1-16 1/32"-5/8"	J6		56	78	96	800	CK3	3303-115
19062			J3		56	78	96	800	CK3	3303-116
19065			Ø 6.5x90°	1/2-20	56	78	96	800	CK3	3303-117
19066			Ø 8.5x90°	5/8-16	56	78	96	800	CK3	3303-118
19072	19H	3-19 1/8"-3/4"	J3	3/4-16	67	89	126	1570	CK4	3303-119
19073				5/8-16	67	89	126	1570	CK4	3303-120
19074	10XH	0.5-10 1/64"-3/8"	J2		45	55	69	390	CK32	3303-121
19075			J2S		45	55	69	390	CK32	3303-122
19045	13XH	1-13 1/32"-1/2"	Ø 6.5x90°	1/2-20	52	69	82	770	CK3	3303-123
19046-1			J6		52	69	82	770	CK3	3303-124
19048			J33		52	69	82	700	CK3	3303-125
19050	13XHC		J33			85	103	900		3303-126
19079	19XH	1-19 1/8"-3/4"	J4		72	96	126	1700	CK4	3303-127

Material Analysis Table

PART NO.	PART NAME	MATERIAL	HEAT TREATED
1	Body	SAE 1045	HRC45-48
2	Case	SAE 1018	HRC38-40
3	Jaw	SAE 2100	HRC52±2
4	Nut	SAE 5145	HRC61±2

Run-out Accuracy & Torque Inspection Table

Type	4H	6.5H	10H	13H	16H	19H	13 XH	19 XH	13 XHC	13 HS
Ø dmm	3.5	6	9	12	15	18	12	18	12	12
Lmm	60	90	110	140	150	150	140	150	140	140
L1mm	40	70	85	110	120	120	110	120	110	110
Max Run-out	0.15	0.15	0.15	0.15	0.15	0.15	0.15	0.15	0.15	0.15
Torque kg-m	18	45	75	85	250	300	190	300	190	85



Modular Boring Systems

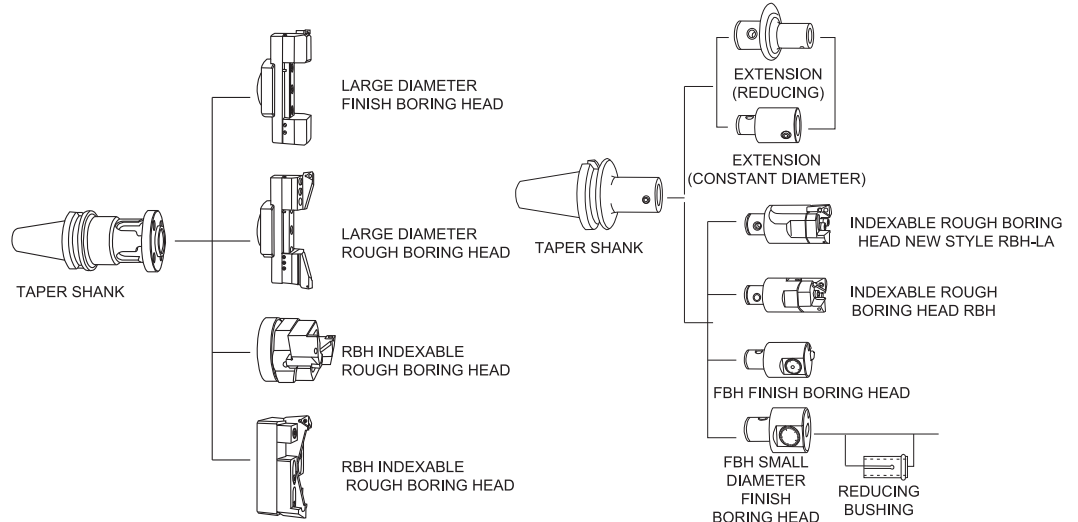

Taper Shank For Boring Heads Series BST, VBK

BST SERIES



VBK SERIES

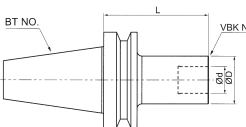
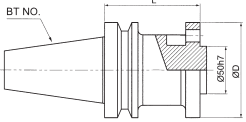

ORDER NO.	Length (L)	External Diameter (D)	Applicable Boring Heads	Weight (kg)	CODE NO.
BT40-VBK1-70	70	19	FBH20	1.2	3220-220
BT40-VBK2-70	70	23	RBH25 ; FBH25	1.3	3220-221
BT40-VBK3-80	80	30	RBH32 ; FBH32	1.45	3220-222
BT40-VBK4-70	70	38	RBH40 ; FBH40 ; CBI4	1.5	3220-223
BT40-VBK4-100	100	38		1.7	3220-224
BT40-VBK5-60	60	50	RBH52 ; FBH25 ; CBI5	1.8	3220-225
BT40-VBK5-80	80	50		1.95	3220-226
BT40-VBK6-55	55	64	RBH68 ; RBH92 ; FBH68 FBH100 ; FBH150 ; CBI6	2.15	3220-227
BT40-BST-90	90	95	RBH120; FBH200 RBH120 and above; FBH200 and above	3.2	3220-228
BT50-VBK1-85	85	19	FBH20	3.5	3220-229
BT50-VBK2-105	105	23	RBH25 ; FBH25	4	3220-230
BT50-VBK2-135	135			4.2	3220-231
BT50-VBK3-110	110	30	RBH32	4.4	3220-232
BT50-VBK3-140	140			4.6	3220-233
BT50-VBK4-100	100	38	RBH40	4.8	3220-234
BT50-VBK4-160	160			5.2	3220-235
BT50-VBK5-90	90	50	RBH52	5.4	3220-236
BT50-VBK5-165	165			6.2	3220-237
BT50-VBK5-210	210			6.4	3220-238
BT50-VBK6-85	85			5.9	3220-239
BT50-VBK6-155	155	64	RBH68 ; RBH92 ; FBH68 FBH100 ; FBH150 ; CBI6	6.5	3220-240
BT50-VBK6-215	215			6.9	3220-241
BT50-BST-105	105	95	RBH120 RBH120 and above; FBH200 and above; large diameter boring heads series	5.71	3220-242
BT50-BST-150	150			7.41	3220-243
BT50-BST-200	200			8.79	3220-244
BT50-BST-250	250			10.26	3220-245
BT50-BST-300	300			11.25	3220-246

Large Diameter Twin-bit Rough Boring

New Modular Style For Diameter Over 200mm

Boring diameter from $\varnothing 200$ - $\varnothing 810$ mm



Boring Head Type	ORDER NO.	RBH 200LA	RBH 300LA	RBH 400LA	RBH 500LA	RBH 600LA	RBH 700LA
Type	Length	130	130	130	130	130	130
	(kg) Total Weight	9.7 kg	11.7 kg	13.7 kg	15.7 kg	17.7 kg	19.7 kg
	D(mm) Boring Diameter	200-310	300-410	400-510	500-610	600-710	700-810
Module	Taper Shank	BT50-BST / NT50-BST BT50-BST / NT50-BST Series					
	Flange	BR200					
	(kg)Weight	2.7 kg					
	ExtensionSlide	RST200	RST300	RST400	RST500	RST600	RST700
	(kg)Weight	3.4 kg	5.4 kg	7.4 kg	9.4 kg	11.4 kg	13.4 kg
	Clamp Base	RS200					
	(kg)Weight	0.98 kg					
	Height Setting Shim	RS201					
	(kg)Weight	0.05 kg					
	Insert Holder	RB200C12	RB200C16	RB200C22	RB200C12		
Applicable Insert	CCMT120404	TCMT16T304	TCMT220404	SCMT120404			
(kg)Weight	0.68 kg						
CODE NO.	3220-250	3220-251	3220-252	3220-253	3220-254	3220-255	







Large Diameter Finish Boring Head

New Modular Style For Diameter Over 200mm

Boring diameter from $\varnothing 200$ - $\varnothing 810$ mm



Boring Head Type	ORDER NO.	FBH200	FBH300	FBH400	FBH500	FBH600	FBH700	
	Length	120	120	120	120	120	120	
	(kg) Total Weight	9.4 kg	11.4 kg	13.4 kg	15.4 kg	17.4 kg	19.4 kg	
	D(mm) Boring Diameter	200-310	300-410	400-510	500-610	600-710	700-810	
Module	Taper Shank		BT50-BST / NT50-BST BT50-BST / NT50-BST Series					
	Flange		BR200					
	(kg) Weight		2.7 kg					
	Extension Slide		RST200	RST300	RST400	RST500	RST600	RST700
	(kg) Weight		3.4 kg	5.4 kg	7.4 kg	9.4 kg	11.4 kg	13.4kg
	Balance Weight		RBN200					
	(kg) Weight		1.6 kg					
	Finish Head		CB200					
(kg) Weight		1.6 kg						
Applicable Insert		TPGB08 TPGB09						
CODE NO.		3220-260	3220-261	3220-262	3220-263	3220-264	3220-265	



Indexable Twin-bit Rough Boring Head RBH

VMH-SYSTEM

Boring diameter from $\varnothing 25$ - $\varnothing 350$ mm

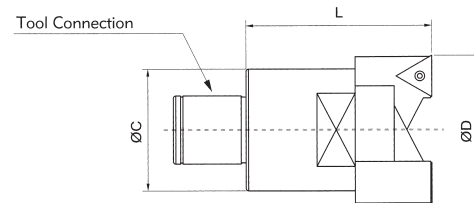

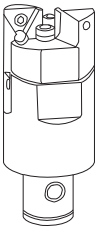
	ORDER NO.	Tool connection	D(mm) Boring Range		L (mm)	C (mm)	insert	(kg) Weight	CODE NO.				
		RBH25-33-C	VBK2	25	33	45	23	CCMT060204	0.15	3220-270			
RBH32-42-C		TCMT110204						3220-271					
RBH32-42-T		VBK3	32	42	55	28	CCMT060204	0.3	3220-272				
RBH40-55-C							TCMT16T304		3220-273				
RBH40-55-T							SCMT09T304		3220-274				
RBH40-55-S		VBK4	40	55	65	36	CCMT09T304	0.5	3220-275				
RBH52-70-C							TCMT16T304		3220-276				
RBH52-70-T							SCMT09T304		3220-277				
RBH52-70-S							CCMT120408		3220-278				
RBH68-92-C		VBK5	52	70	75	48	TCMT16T304	1	3220-279				
RBH68-92-T							SCMT120404		3220-280				
RBH68-92-S							CCMT120408		3220-281				
RBH90-122-C	VBK6	68	92	85	60	TCMT16T304	2	3220-282					
RBH90-122-T						SCMT120404		3220-283					
RBH90-122-S						CCMT120408		3220-284					
RBH120-164-C	VBK6	90	122	100	80	TCMT220408	2.9	3220-285					
RBH120-164-T						SCMT120404		3220-286					
RBH120-164-S						CCMT120408		3220-287					
RBH160-204-C						BST		120	164	90	TCMT220408	3.8	3220-288
RBH160-204-T											SCMT120404		3220-289
RBH160-204-S											CCMT120408		3220-290
RBH200-254-C	BST Series	160	204	130	170	TCMT220408	4.8	3220-291					
RBH200-254-T						SCMT120404		3220-292					
RBH200-254-S						CCMT120408		3220-293					
RBH250-304-C						250		254	95	170	TCMT220408	6.5	3220-294
RBH250-304-T											SCMT120404		3220-295
RBH250-304-S											CCMT120408		3220-296
RBH300-354-C	250	304	210	260	TCMT220408	8.3	3220-297						
RBH300-354-T					SCMT120404		3220-298						
RBH300-354-S					CCMT120408		3220-299						



Taper Shank For Boring Heads Series BST, VBK

Modular Boring Systems

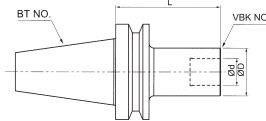
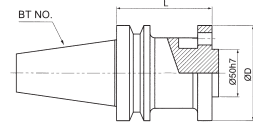
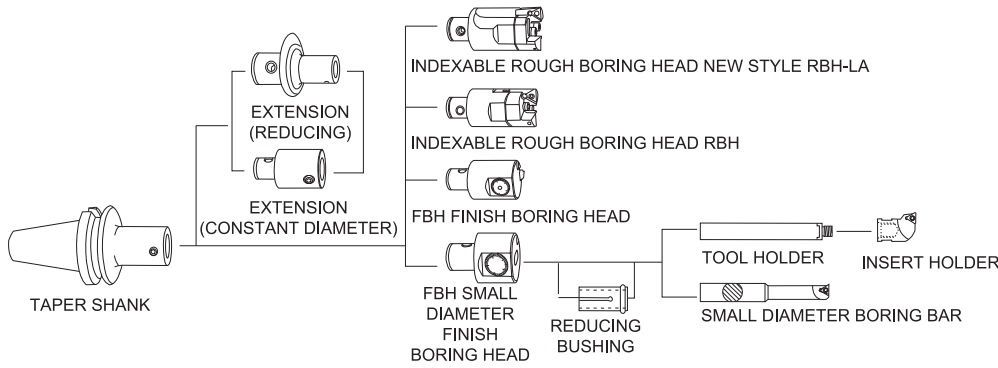

ORDER NO.	Length (L)	External Diameter (D)	Applicable Boring Heads	Weight (kg)	CODE NO.
BT40-VBK1-70	70	19	FBH20	1.2	3220-220
BT40-VBK2-70	70	23	RBH25 ; FBH25	1.3	3220-221
BT40-VBK3-80	80	30	RBH32 ; FBH32	1.45	3220-222
BT40-VBK4-70	70	38	RBH40 ; FBH40 ; CBI4	1.5	3220-223
BT40-VBK4-100	100			1.7	3220-224
BT40-VBK5-60	60	50	RBH52 ; FBH25 ; CBI5	1.8	3220-225
BT40-VBK5-80	80			1.95	3220-226
BT40-VBK6-55	55	64	RBH68 ; RBH92 ; FBH68 FBH100 ; FBH150 ; CBI6	2.15	3220-227
BT40-BST-90	90	95	RBH120 ; FBH200 RBH120 and above ; FBH200 and above	3.2	3220-228
BT50-VBK1-85	85	19	FBH20	3.5	3220-229
BT50-VBK2-105	105	23	RBH25 ; FBH25	4	3220-230
BT50-VBK2-135	135			4.2	3220-231
BT50-VBK3-110	110			4.4	3220-232
BT50-VBK3-140	140	30	RBH32	4.6	3220-233
BT50-VBK4-100	100			4.8	3220-234
BT50-VBK4-160	160			5.2	3220-235
BT50-VBK5-90	90	50	RBH52	5.4	3220-236
BT50-VBK5-165	165			6.2	3220-237
BT50-VBK5-210	210			6.4	3220-238
BT50-VBK6-85	85	64	RBH68 ; RBH92 ; FBH68 FBH100 ; FBH150 ; CBI6	5.9	3220-239
BT50-VBK6-155	155			6.5	3220-240
BT50-VBK6-215	215			6.9	3220-241
BT50-BST-105	105	95	RBH120 RBH120 and above ; FBH200 and above ; large diameter boring heads series	5.71	3220-242
BT50-BST-150	150			7.41	3220-243
BT50-BST-200	200			8.79	3220-244
BT50-BST-250	250			10.26	3220-245
BT50-BST-300	300			11.25	3220-246

Extension (Reducing)

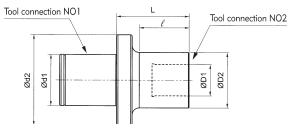
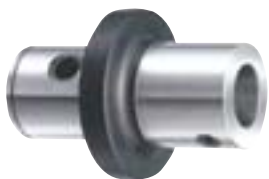

ORDER NO.	d1	d2	D1	D2	L	ℓ	Applicable Boring Heads	(kg)Weight	CODE NO.		
VBK2-1-36L	14	24	11	19	36	30	FBH20	0.1	3220-301		
VBK3-1-41L	18	31		24	41	30	FBH20	0.15	3220-302		
VBK3-2-37L			14	24	37	25	RBH25 ; FBH25	0.15	3220-303		
VBK4-1-58L	22	39	11	19	58	40	FBH20	0.3	3220-304		
VBK4-2-50L				24	50	36	RBH25 ; FBH25	0.3	3220-305		
VBK4-3-50L				18	31	50	37	RBH32 ; FBH32	0.35	3220-306	
VBK5-1-60L	28	50	11	19	60	40	FBH20	0.45	3220-307		
VBK5-2-54L				14	24	54	35	RBH25 ; FBH25	0.45	3220-308	
VBK5-2-74L						74	55	RBH25 ; FBH25	0.5	3220-309	
VBK5-3-47L				18	31	18	47	29	RBH32 ; FBH32	0.5	3220-310
VBK5-3-72L							72	54	RBH32 ; FBH32	0.6	3220-311
VBK5-4-42L							42	25	RBH40 ; FBH40	0.5	3220-312
VBK5-4-67L	67	50	RBH40 ; FBH40				0.7	3220-313			
VBK6-1-70L	36	64	11	19	70	40	FBH20	0.9	3220-314		
VBK6-2-63L				14	24	14	63	45	RBH25 ; FBH25	0.7	3220-315
VBK6-2-93L							93	75	RBH25 ; FBH25	0.8	3220-316
VBK6-3-56L				18	31	18	56	39	RBH32 ; FBH32	0.75	3220-317
VBK6-3-96L							96	79	RBH32 ; FBH32	0.95	3220-318
VBK6-4-51L							51	35	RBH40 ; FBH40	0.85	3220-319
VBK6-4-101L							101	85	RBH40 ; FBH40	1.3	3220-320
VBK6-5-41L				22	39	22	41	25	RBH52 ; FBH52	0.85	3220-321
VBK6-5-91L							91	75	RBH52 ; FBH52	1.45	3220-322

Extension (Constant Diameter)

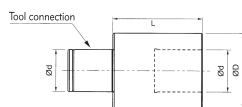

ORDER NO.	d	D	L	Applicable Boring Heads	(kg)Weight	CODE NO.
VBK1-1-30L	11	19	30	FBH20	0.07	3220-323
VBK2-2-30L	14	24	30	RBH25 ; FBH25	0.1	3220-324
VBK3-3-30L	18	31	30	RBH32 ; FBH32	0.15	3220-325
VBK4-4-45L	22	39	45	RBH40 ; FBH40 ; CBI4	0.4	3220-326
VBK5-5-60L	28	50	60	RBH52 ; FBH52 ; CBI5	0.8	3220-327
VBK6-6-60L	36	64	60	RBH68/RBH90 ; FBH68, 100, 150 ; CBI6	1.4	3220-328



Indexable Twin-bit Rough Boring Head RBH-LA

Boring range from $\varnothing 25\text{mm}$ to $\varnothing 810\text{mm}$;
a variety of tool holders and boring heads are for your selection.



DRDOR NO.	Tool Connection	D(mm) Boring Range	L (mm)	C (mm)	Insert	(kg) Weight	CODE NO.
RBH25-35LA-C	VBK2	25-35	50	24	CCMT060204	0.15	3220-340
RBH32-45LA-C	VBK3	32-45	60	31	CCMT060204	0.3	3220-341
RBH32-45LA-T					TCMT110204		3220-342
RBH40-55LA-C	VBK4	40-55	74	39	CCMT09T304	0.6	3220-343
RBH40-55LA-T					TCMT16T304		3220-344
RBH40-55LA-S					SCMT09T304		3220-345
RBH52-75LA-C	VBK5	52-75	80	50	CCMT09T304	1	3220-346
RBH52-75LA-T					TCMT16T304		3220-347
RBH52-75LA-S					SCMT09T304		3220-348
RBH68-100LA-C	VBK6	68-100	90	66	CCMT120408	2.5	3220-349
RBH68-100LA-T					TCMT16T304		3220-350
RBH68-100LA-S					SCMT120404		3220-351
RBH90-130LA-C	VBK6	90-130	100	88	CCMT120408	3.1	3220-352
RBH90-130LA-T					TCMT16T304		3220-353
RBH90-130LA-S					SCMT120404		3220-354
RBH120-164LA-C	BST	120-164	95	95	CCMT120408	3.8	3220-355
RBH120-164LA-T					TCMT220408		3220-356
RBH120-164LA-S					SCMT120404		3220-357
RBH160-204LA-C		160-204	130	130	CCMT120408	4.8	3220-358
RBH160-204LA-T					TCMT220408		3220-359
RBH160-204LA-S					SCMT120404		3220-360
RBH200-310LA	BST Series	200-310	130	180	Optional Inserts CCMT120408 TCMT16T304 TCMT220408 SCMT120404	9.7	3220-361
RBH300-410LA		300-410		280		11.7	3220-362
RBH400-510LA		400-510		380		13.7	3220-363
RBH500-610LA		500-610		480		15.7	3220-364
RBH600-710LA		600-710		580		17.7	3220-365
RBH700-810LA		700-810		680		19.7	3220-366

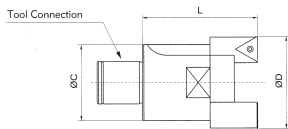
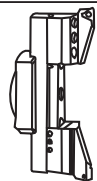
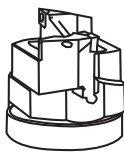
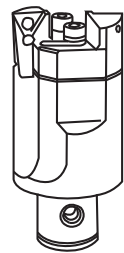

FBH Finish Boring Head

Boring diameter from $\varnothing 20 - \varnothing 810\text{mm}$

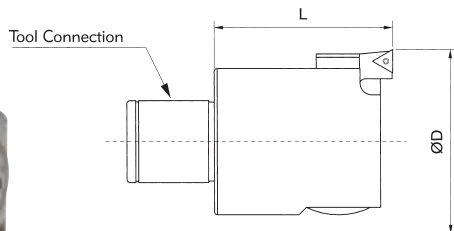

Ordering Example

FBH 52-75 — VBK5
 Head Type Boring Diameter Tool Connection

FEATURES:

1. FBH finish boring head is suitable for finish boring with working ranges from $\varnothing 20\text{mm}$ to $\varnothing 810\text{mm}$ on diameter.
2. The dial has been graduated into 50 divisions, each of which is 0.01mm on diameter. Available is a sub-dial for finer adjustment.
3. High precision internal lead screw with inner lubrication is free from the effects of chip, featuring high durability.
4. Coolant nozzle easily cools the insert elongating its working life.
5. Cartridge unit is housed in a square structure with two face support, proving high stability and rigidity.

ORDER NO. Boring Head Type	Tool Connection	$\varnothing D$ Diameter	length	Weight	Insert/Clamping Ssrew	CODE NO.
FBH20	VBK1	20-26	35	0.1	TP08/M2.2;TP06/M2	3220-370
FBH25	VBK2	25-33	40	0.2		3220-371
FBH32	VBK3	32-42		0.3		3220-372
FBH40	VBK4	40-55	50	0.5		3220-373
FBH52	VBK5	52-75	60	1	TP08/M2.2;TP09/M2.5	3220-374
FBH68	VBK6	68-102	72	2		3220-375
FBH100	VBK6	100-152		2.9		3220-376
FBH150	VBK6	150-202		4.2		3220-377
FBH200	BST Series	200-310	120	9.7		3220-378
FBH300		300-410		11.7		3220-379
FBH400		400-510		13.7		3220-380
FBH500		500-610		15.7		3220-381
FBH600		600-710		17.7		3220-382
FBH700		700-810		19.7		3220-383



Small Diameter Finish Boring Head Type CBI

BORING DIAMETER FROM Ø8 - Ø40MM

FEATURES:

1. Available are three different styles enabling small diameter boring from ø8mm to ø40mm. Boring range can be within ø2mm to ø8mm if small diameter solid carbide boring bar has been employed.
2. The dial has been graduated into 50 divisions, each of which is 0.01mm on diameter. Available is a sub-dial for finer adjustment.
3. High precision internal lead screw with inner lubrication is free from the effects of chip, featuring high durability.
4. Cartridge unit is housed in a square structure with two face support, proving high stability and rigidity.

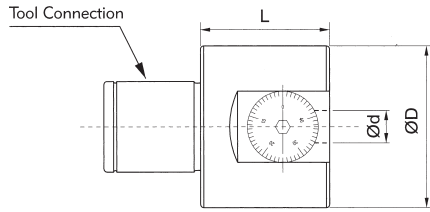

ORDER NO. Boring Head Type	Tool Connection	Ød Internal Diameter	ØD External Diameter	Length mm	Feed mm	kg Weight	CODE NO.
CBI4	VBK4	10	39	32	0 - 2	0.4	3220-390
CBI5	VBK5	12	50	40	0 - 3.5	0.8	3220-391
CBI6	VBK6	16	64	50	0 - 5	1.2	3220-392

ORDER NO	D mm	D1 mm	Applicable Carbide Tool Holder	O.
EC1608	16	8	SC08-M5-....	3220-393
EC1610	16	10	SC10-M6-....	3220-394
EC1612	16	12	SC12-M6-....	3220-395



Small Diameter Boring Head CBI4

BORING DIAMETER FROM Ø8 - Ø20MM

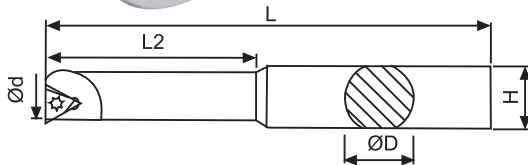
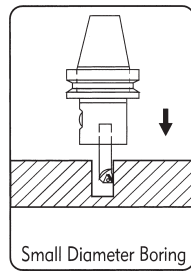

ORDER NO.	ØD mm	Ød mm	L mm	L2 mm	H mm	Insert	Clamp Screw	Wrench	CODE NO.
BJ1008-32	10	8	64	32	9	TB..0601..	MS2005A	TF6	3220-440
BJ1010-40		10	72	40					3220-401
BJ1012-45		12	77	27		TP..0902..	MS2506A	TF9	3220-402
BJ1016-45		16	77	27					3220-403
BJ1020-45		20	77	27					TP..1103..
※BJ16-8PCS	BJ1008-32	BJ1010-40	BJ1012-45	BJ1016-45	BJ1020-45				3220-405



Small Diameter Boring Head CBI6

BORING DIAMETER FROM Ø8 - Ø40MM

※ In Box Package

※ Note: Outstretch of small diameter boring is better within 3 times of its diameter when in use.

ORDER NO.	ØD mm	Ød mm	L mm	L2 mm	H mm	Insert	Clamp Screw	Wrench	CODE NO.
BJ1608-32	16	8	74	32	15	TB..0601..	MS2005A	TF6	3220-406
BJ1610-40		10	75	40					3220-407
BJ1612-53		12	85	53		TP..0902..	MS2506A	TF9	3220-408
BJ1616-68		16	100	68					3220-409
BJ1620-83		20	115	83					TP..1103..
BJ1625-90		25	122	90		3220-411			
BJ1630-90		30	122	90		3220-412			
BJ1640-90		40	122	90		3220-413			
※BJ16-8PCS	BJ1608-32	BJ1610-40	BJ1612-53	BJ1616-68	BJ1620-83	BJ1625-90	BJ1630-90	BJ1640-90	3220-414



Carbide Tool Holder

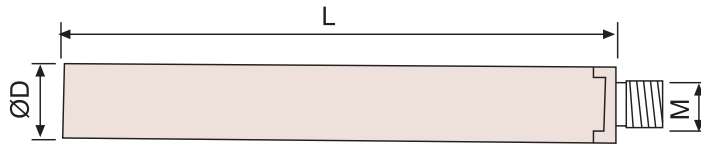

Small Diameter Modular Boring Bar

BORING DIAMETER FROM Ø8 - Ø16MM

ORDER NO.	L mm	D mm	M mm	Applicable Insert Holder	Applicable Bushing	CODE NO.
SC08-M5-115	115	8	M5	BE09A, BE10.5A	EC1608	3220-420
SC10-M6-115	115	10	M6	BE12A	EC1610	3220-421
SC10-M6-135	135					3220-422
SC10-M6-160	160					3220-423
SC12-M6-135	135	12		BE14A, BE16A	EC1612	3220-424
SC12-M6-165	165					3220-425
SC16-M10-180	180	16	M10	BE18A, BE20A, BE22A, BE24A, BE26A, BE28A, BE30A, BE32A, BE34A, BE36A, BE38A, BE40A	---	3220-426

Insert Holder

BORING DIAMETER FROM Ø9 - Ø40MM

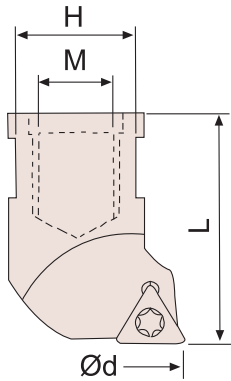

ORDER NO.	d(mm)	H(mm)	L(mm)	M(mm)	Insert	Clamping Screw	Wrench	CODE NO.
BE09A	9	7	18	M5	TP..0808..	MS2206A	TF7	3220-430
BE10.5A	10.5	7						3220-431
BE12A	12	8	23	M6				3220-432
BE14A	14	10						3220-433
BE16A	16	10						3220-434
BE18A	18	14	27	M10				3220-435
BE20A	20	14						3220-436
BE22A	22	14						3220-437
BE24A	24	14						3220-438
BE26A	26	14						3220-439
BE28A	28	14						3220-440
BE30A	30	14						3220-441
BE32A	32	14						3220-442
BE34A	34	14						3220-443
BE36A	36	14						3220-444
BE38A	38	14						3220-445
BE40A	40	14						3220-446

RBH Indexable Twin-bit Rough Boring Head

BORING DIAMETER FROM Ø25 - Ø350MM

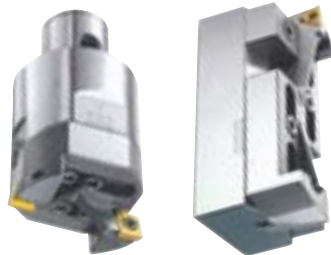

1. The head is suitable for single bit boring, twin-bit boring and step boring with working diameter from ø25mm to ø350mm on diameter.
2. New cartridge style with built-up rib. The pressure imposed on both cartridges counteracts producing highest rigidity and cutting efficiency, most suitable for a variety of borings.
3. Boring head can be easily adjusted to different boring needs for machining on demand. Boring depth can be extended by tool connection.
4. Clear side division provides a convenient adjustment without using a tool presetter.
5. Most suitable for boring on various machine centers or boring mills. Universal design accepts inserts of any brands, which will reduce tool grinding and greatly improve boring performance.
6. Patented step boring design; suitable for both level boring and step boring.

Indexable Twin-bit

Rough Boring Head RBH-LA

BORING DIAMETER FROM Ø25 - Ø200MM



1. Thickened cartridge with higher rigidity.
2. Coolant nozzle easily cools the insert elongating its working life.
3. Completed with chip pocket, improving chip flow of deep boring.
4. Clamp plate solidifies cartridges and head, upgrading cutting rigidity.
5. Patented step boring design; suitable for both level boring and step boring.

Large Diameter Modular

Rough Boring Head With

Diameter Over Ø200mm

BORING DIAMETER FROM Ø200 - Ø810MM



1. This type is suitable for large diameter boring with ranges from ø200mm to ø810mm.
2. The structure includes common flange and extension slide for both rough and finish boring heads. Available can be optional accessories for different works. Adjustment range is within 110mm on diameter.
3. Options of various inserts for rough boring of different materials and boring styles.
4. Available is the horizontal slide made of Aluminum alloy to reduce total weight.
5. Options of external boring kit with boring range from ø20mm to ø300mm.



Universal Boring And Facing Master Head

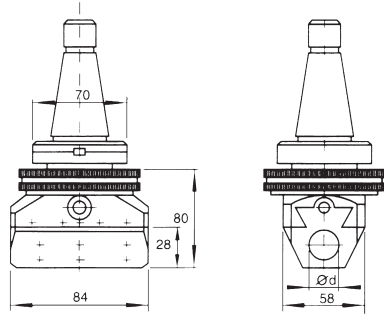

FULL SET

ORDER NO.	SHANK TYPE	DRAWBAR S.A.E.	THREAD METRIC	WEIGHE (kg)	CODE NO.
VBHU-202	MT-3	1/2"-12W	M12X1.5P	4.6	3401-001
VBHU-203	MT-4	5/8"-11W	M16X2.0P	5	3401-002
VBHU-204	MT-5	1"-8W	M24X3.0P	6	3401-003
VBHU-205	R-8	7/16"20UNF	n/a	4.8	3401-004
VBHU-206	NT-30	1/2"12W	M12X1.75P	4.5	3401-005
VBHU-207	NT-40	5/8"-11W	M16X2.0P	4.9	3401-006
VBHU-208	NT-50	1"-8W	M24X3.0P	7.6	3401-007
VBHU-209	BT-40		M16X2.0P	5.6	3401-008

SPECIFICATION

Unit:mm

VBHU	ACTUAL SIZE	OVERING BAR HOLE SIZE	BORING BAR HOLE SIZE	CENTER DIST BETWEEN HOLES.	CROSS HOLE DIA	OFFSET
	84	100	18	23	18	15

It is construction with precision parts, freedom of selection feeding quantity, auto feed and stop. Processing range from 5mm to 250mm.

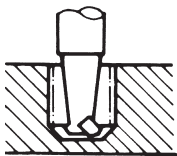

Boring with several different bits from 5 \varnothing -250mm

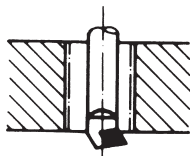

From inside outward

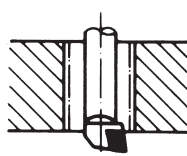

From inside inward

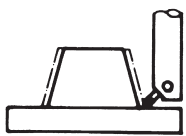

Taper turning

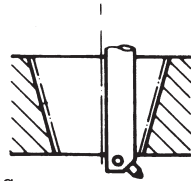

Outside turning

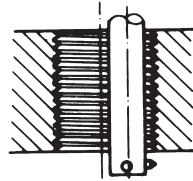

Thread Cutting

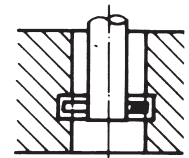

Recessing

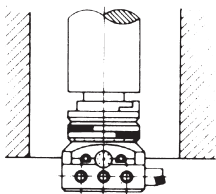

Because of the small construction of the facing and boring heads deep bores can be made. In this case the boring bit is fixed directly in the side.

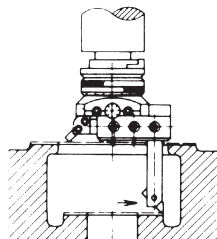

Facing in two areas with one boringbar and boringbar holder

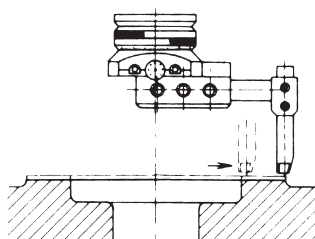

Facing of large \varnothing with long boringbar holden reinforced by rings and draw in screw

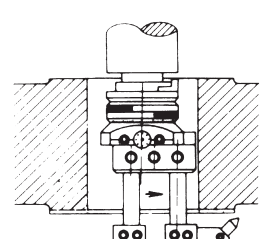

Facing of the reverse side by using boringbar holders contained in attachment.

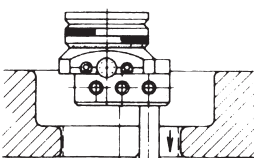

Boring with long boringbar

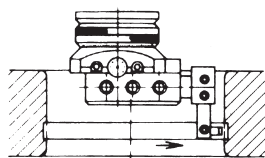

Recessing with short boringbar holder and a boringbar

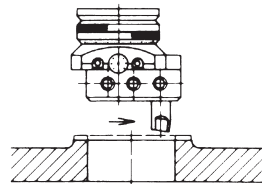

Facing with bit fixed directly in slide

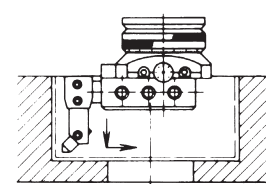

Boring and tacing with short boringbar holder and a boringbar



Interchangeable Shanks

SHANK

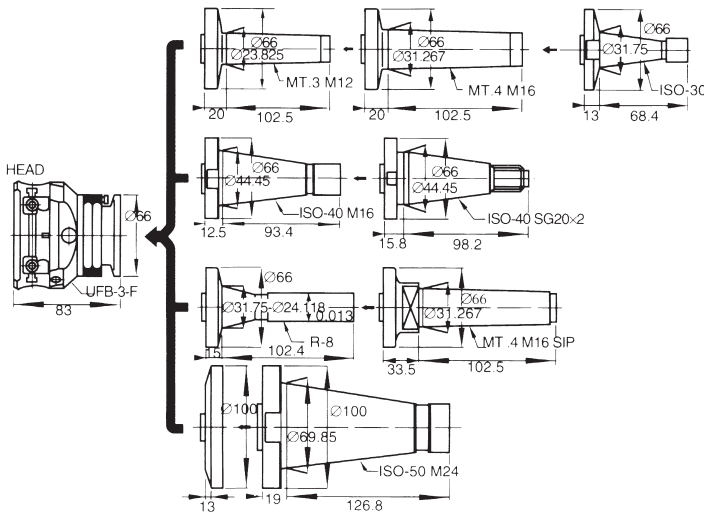

VBHU-NT-30,40 R-8, MT-3, MT-4, MT-5, BT-40, BT-50

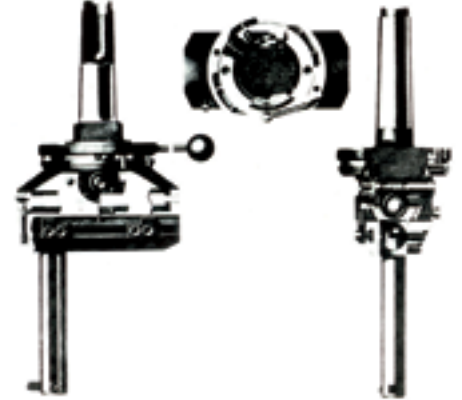

Main part of the universal boring heads is the body(1), in which the tool slide (3) moves on dovetail guideways. The tool slide is provided with holes for accommodation of tools and tool holders(4). In boring holes or turning external cylindrical surfaces, the tool is adjusted with the aid of the graduated dial for fine setting of tool slide(5), one division of which means a change in diameter of bored hole by .0005".

On the types rapid adjustment of the tool slide(3) can be produced by rotating the graduated dial for quick adjustment of the tool slide(2).

During recessing, turning of front or rear facings or similar jobs calling for automatic transverse feed movement to the tool slide, the preselected feed movement to the tool slide is engaged with the aid of the engagement ring (6). After setting of tool, the automatic transverse feed movement to the tool slide is started by braking of the brake ring(7), by means of the handle(8).

The clutch(9) provides for tripping of the automatic feed movement when cutting resistance increases or when the trip dog is approached.

Mechanism of the boring heads has a lubrication circuit delivering oil from two lubricators to all friction surfaces.

All parts are hardened and working surfaces are ground.

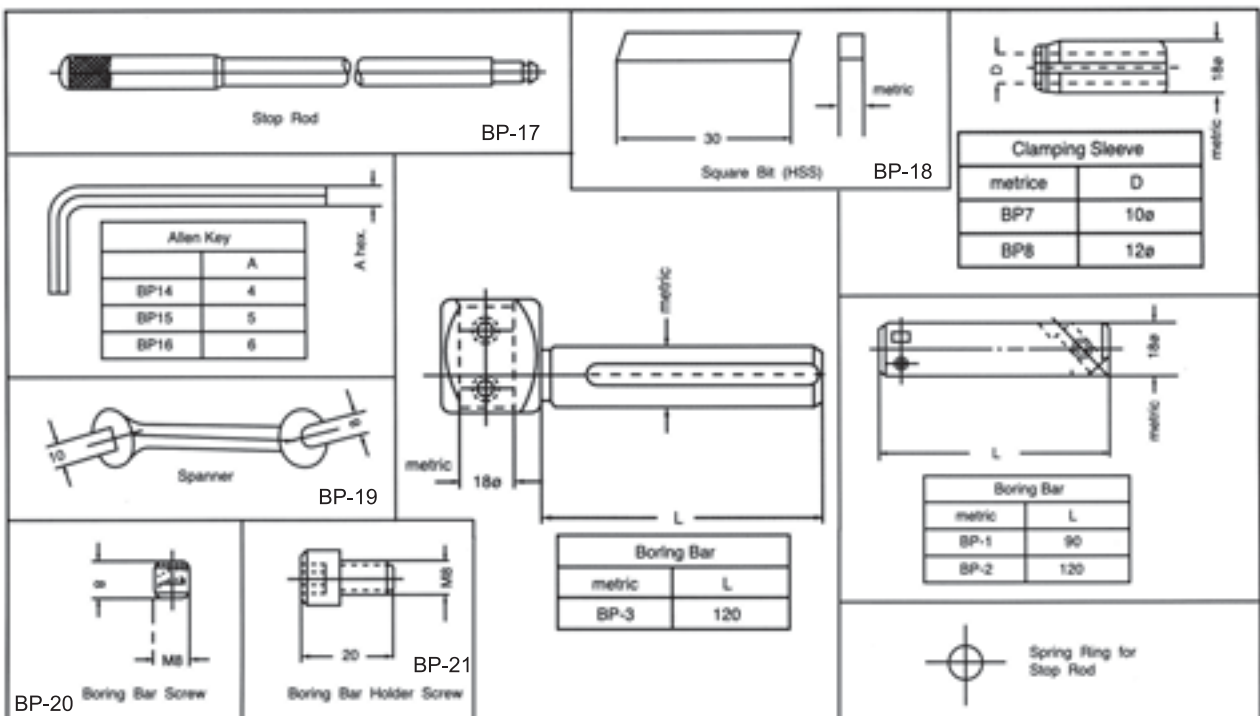
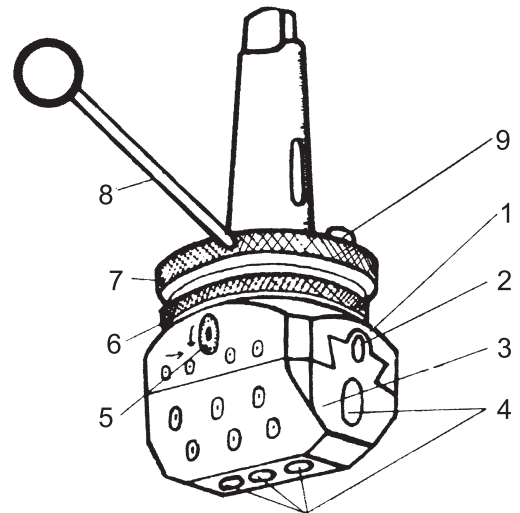



Boring Head Sets

STANDARD TYPE



INSERT NO.
TBGT060102L-W-T1200A FOR STEEL
TBGT060102L-W-T110A FOR CASTING
"SUMITOMO" BRAND

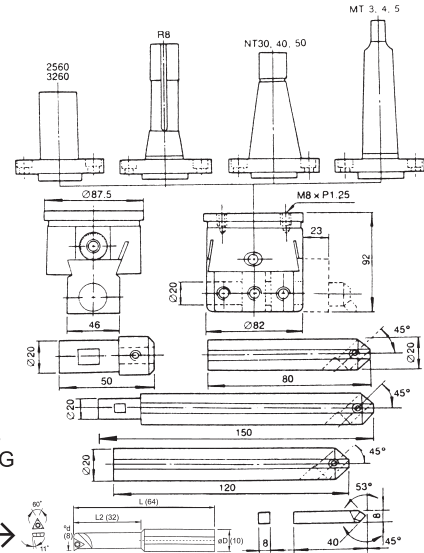

FULL SET

	SHANK TYPE	DRAWBAR S.A.E.	THREADS METRIC	WEIGHT (kg)	CODE.NO.
VBH-102	MT3	PLATE TONE	-	7	3401-101
VBH-103	MT4		-	7	3401-102
VBH-104	MT5	1"~8W	M24X3.0P	7	3401-103
VBH-105	R8	7/16"~20UNF	7/16"-20	7	3401-104
VBH-106	NT30	1/2"-12W or 1/2"-13W	M12X1.75P	7	3401-105
VBH-107	NT40	5/8"-11W	M16X2.0P	7	3401-106
VBH-108	NT50	1"~8W	M24X3.0P	10	3401-107
VBH-109	BT40	-	M16X2.0P	10	3401-108
VBH-110	SK40	-	M16X2.0P	-	3401-109
VBH-111	C25	-	-	7	3401-110

Processing Range $\varnothing 10 \sim \varnothing 240\text{mm}$

Simple, extremely rigid construction, Finest materials and craftsmanship are employed to combine strength, flexibility and accuracy in a tool of unique design. 2 vertical boring tool holes: one centered and one offset. One cross hole for greater versatility and capacity. Dependable adjustment --- far spread graduation for closer reading. Perfectly balanced for high speed operation.

Precision ground & hardened shank are integral with the head for routing and smoother operation.



Boring Head Set C-Type



VBHC-BC2 SET TYPE

VBHC-SHANK SIZE-VBC-2	WEIGHTY (kg)
VBHC-SHANK SIZE-VBC-2	1.4
VBHC-SHANK SIZE-VBC-3	1.4

ORDER NO.	WEIGHT (kg)	CODE.NO.
VBHC-R-8-BC-2	2	3401-150
VBHC-MT-3-BC-2	1.84	3401-151
VBHC-MT-4-BC-2	2.35	3401-152
VBHC-NT-30-BC-2	2	3401-153
VBHC-NT-40-BC-2	2.6	3401-154



VBHC-BC3 SET TYPE

Here is a sturdy unit of extended boring range, capable of peeling off heavy roughing cuts as well as a tool of extreme sensitivity. The use of a wide base bar holder, resting securely on the body, eliminates the need for a separate side plate. You will note this has now become an integral part of the body. The direct reading adjusting screw is ground after hardening and a plainly marked dial face in nonreflecting satin chrome allows easy reading and adjustments of .005 or less. All Criterion Boring Heads have threaded backs for use with a variety of shanks. This model takes a 1-1/2"-18 threaded shank. SHANK SIZE: NT-30,40,50, MT-3,4,5,R8

DER NO.	WEIGHT (kg)	CODE.NO.
VBHC-R-8-BC-3	4.2	3401-160
VBHC-MT-3-BC-3	4.4	3401-161
VBHC-MT-4-BC-3	4.6	3401-162
VBHC-NT-30-BC-3	4.2	3401-163
VBHC-NT-40-BC-3	4.8	3401-164
VBHC-NT-50-BC-3	6.8	3401-165



Shank For C-Type Boring Head

ORDER NO. VBC-R8, NT30, NT40,
MT3,MT4, MT5.

The shanks are made for C-type boring head use.
Also, can be replaced from time to time.



ORDER NO.	VBC-R8	VBC-NT30	VBC-NT40	VBC-MT3	VBC-MT4	VBC-MT5
CODE NO.	3401-210	3401-211	3401-212	3401-213	3401-214	3401-215
WEIGHT(kg)	0.615	0.58	1.18	0.45	0.78	1.61



C-Type Boring Head



ORDER NO. VBC-2

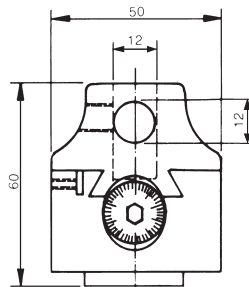

Here is a small head that will be in constant demand in any shop.

Note the wide base bearing surface that assures maximum rigidity even when the bar holder is in an off-set position. This wide base design is a recent Criterion innovation that increases bearing surfaces by 50% over the older models.

A choice of either 3/8" or 1/2" double hole bar holder with a 1/2" cross hole is available.

The unit has a 1 1/2"-18NC threaded back and also features a direct reading dial screw.

SPECIFICATION

BORING CAPACITY Ø10-Ø100

ORDER NO.	ACTUAL SIZE	OVERALL LENGTH	BORING BAR HOLE SIZE	CENTEN DIST BETWEEN HOLES.	CROSS HOLE DIA	OFFSET	WEIGHT (kg)	CODE NO.
VBC-2(l)	2" Dia.	2-7/16"	1/2"	5/8"	1/2"	5/8"	0.7	3401-301
VBC-2(m)	50	62	12	15	12	15	0.7	3401-302



ORDER NO. VBC-3

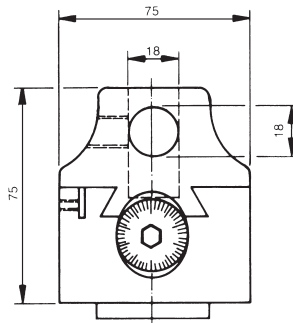

Here is a sturdy unit of extended boring range, capable of peeling off heavy roughing cuts as well tool of extreme sensitivity. The use of a wide base bar holder, resting securely on the body, eliminates the need for a separate side plate. You will not this has now become an integral part of the body.

The direct reading adjusting screw is ground after hardening and a plainly marked dial face in non-reflecting satin chrome allows easy reading and adjustments of .0005 or less.

All Criterion Boring Heads have threaded backs for use with a variety of shanks. This model takes a 1-1/2"-18 threaded shank.

SPECIFICATION

BORING CAPACITY Ø10-Ø220

ORDER NO.	ACTUAL SIZE	OVERALL LENGTH	BORING BAR HOLE SIZE	CENTEN DIST BETWEEN HOLES.	CROSS HOLE DIA	OFFSET	WEIGHT (kg)	CODE NO.
VBC-3(l)	3" Dia.	3.5/32"	3/4"	15/16"	3/4"	1"	2	3401-303
VBC-3(m)	75	80	18	23	18	25	2	3401-304



ORDER NO. VBC-4

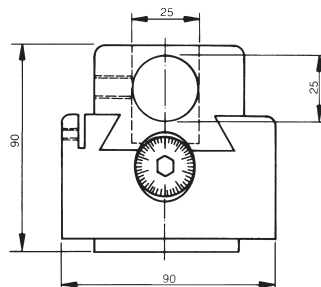

This is a bigger boring head which can be put on a large machine to process more as you want. The radius of boring hole can reach on about Ø 400mm long by a boring bar of 160mm.

SPECIFICATION

BORING CAPACITY Ø10-Ø250

ORDER NO.	ACTUAL SIZE	OVERALL LENGTH	BORING BAR HOLE SIZE	CENTEN DIST BETWEEN HOLES.	CROSS HOLE DIA	OFFSET	WEIGHT (kg)	CODE NO.
VBC-4(l)	4" Dia.	3-1/2"	1"	1-1/4"	1"	1"	4	3401-305
VBC-4(m)	100	90	25	32	25	25	4	3401-306



Touch Point Sensor

With beeper

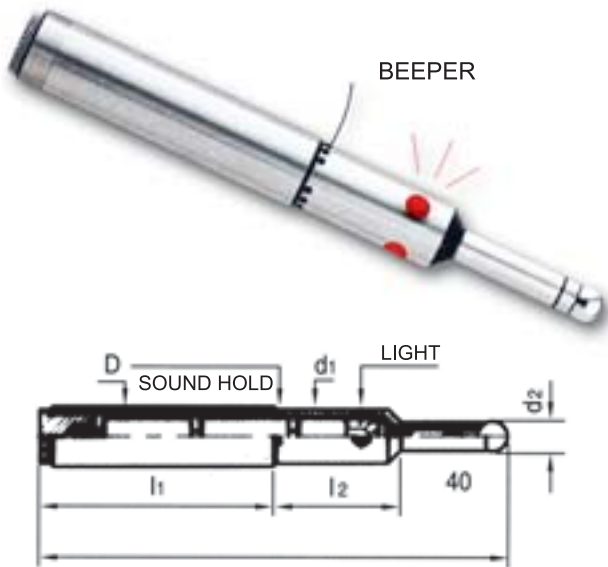

- No need to rotate while measuring.
- The red lamp with setting red glue, it can concentrate light and resist water.
- It will give up beep sound at the same time when the red lamp light up.
- When work lamp light up to be influence visual sense, it can be probe by the beep sounder.
- It can be sound due in thr reverse side and can't seeing of the aide.
- When probe the deep hole while you can't see the red light, but you can hear the sound by the sounder.
- Accuracy:within 0.005mm

OPTICAL TYPE WITH BEEPER

Unit:mm

ORDER NO.	D	d1	d2	L	l1	l2	BATTERY TYPE	WEIGHT	CODE NO.
VPS-20B	∅20	18	10	160	79	41	UM-5#(SP)	0.32kg	3402-001
VPS-32B	∅32	18	10	160	79	41	x2PCS	0.6kg	3402-002



Touch Point Sensor

Optical Type



OPTICAL TYPE

Unit:mm

ORDER NO.	D	d1	d2	L	l1	l2	BATTERY TYPE	WEIGHT (kg)	CODE NO.
VPS-20	20	16	10	157	77	35	UM-5#(SP)	0.35	3402-003
VPS-32	32	16	10	157	71	41	x 2P/R1./1.5V	0.6	3402-004

- High sensitivity location sensor.
- Red pilot can be seen clearly.
- Whole travel of red pilot is sparkling, detecting also can be done during turning while spindle stops.
- Location of end surface, outside circle dia.,inside circle dia. of the workpiece for processing can be detected with full effect.
- Devised with safety line excess, ball supported by spring, so even line excess, it will be sepatated easily from the base shown as the fig. The precision to return to its original position will reach up to micrometer.

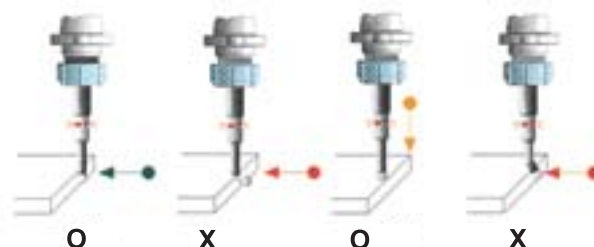
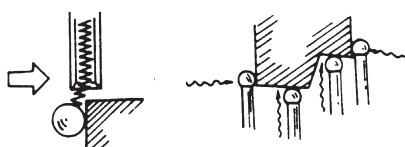



Touch Point Sensor

With Beeper



CERAMIC TYPE VPS-201C

The series is a high precision setting device for positioning the accurate center between tool spindle of machine and reference surface of working at low-cost and saving time.

Accuracy ; within 0.005 mm

Made of tool steel, hardened and ground.

Suitable rotation speed : VPS-201-450 to 600rpm.

VPS-401-600 to 1,000 rpm

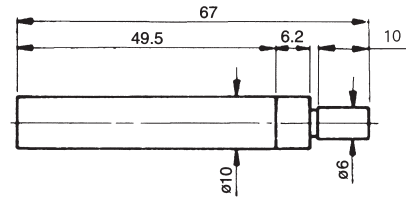

MECHANICAL TYPE SIMPLE TYPE

ORDER NO.	VPS-201	VPS-201C
CODE NO.	3402-005	3402-007
WEIGHT(kg)	0.1	0.1



Touch Point Sensor

VPS-401 (2 PCS/SET)
VPS-402A(LONG) SINGLE
VPS-402B(SHORT) SINGLE

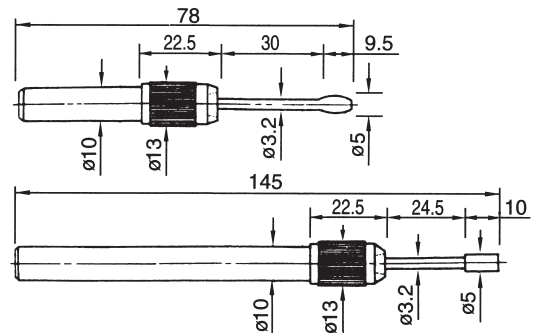

DELUXE TYPE

ORDER NO.	VPS-401 (2PCS/SET)
CODE NO.	3402-006
WEIGHT(kg)	0.18

FEATURES

1. Material: high-carbon steel.
2. Accuracy within 0.003mm
3. Hardness: HRC 58° ± 1°
4. R.P.M. Within 600-1000
5. Suitable for milling machine, Drill machine, and boring machine.

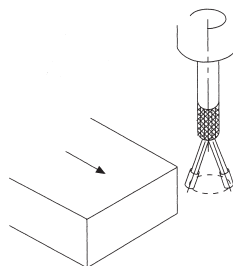

EXAMPLES-APPLICATION

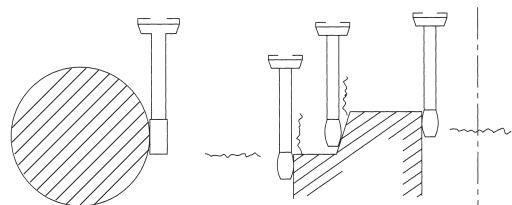



Touch Point Sensor



MECHANICAL TYPE

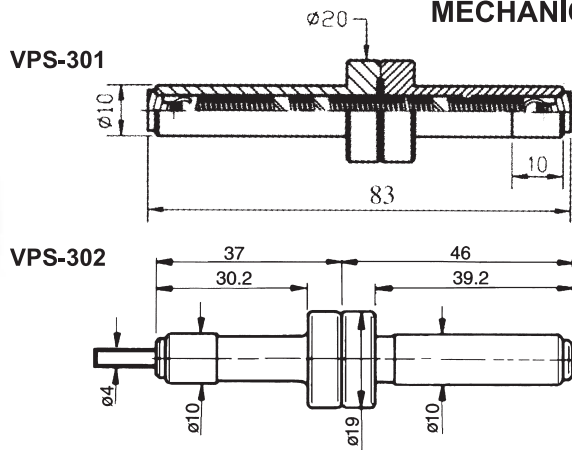

- Accuracy of zero point to point is within 0.003mm.
- R.P.M. within 450-600.
- Max. flange can be clear your sight sense.
- MIN. (4mm) can be test mini hole for your workpiece.

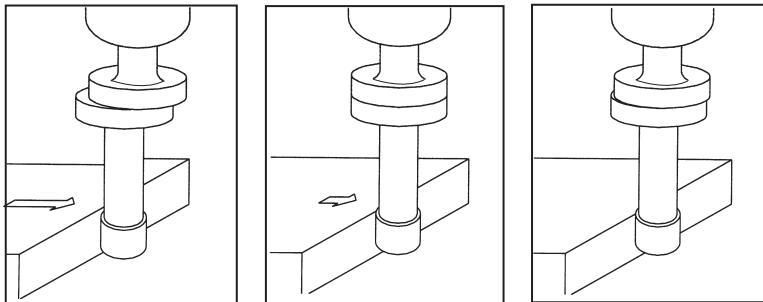

Spindle runs about 500rpm. move spindle closed to measuring surface.

When measuring probe touches workpiece, it looks in one part.

When the probe and shank are in alignment, probe will slide out of rotating center. Now, the center spindle is located 5mm away from measuring surface.

ORDER NO.	MATERIAL	HARDNESS	WEIGHT (kg)	CODE NO.
VPS-301	ALLOY	HRC 56°	0.03	3402-100
VPS-302	STEEL	HRC 56°	0.03	3402-101
VPS-301S	STAINLESS	HRC 60°	0.03	3402-102
VPS-302S	STAINLESS	HRC 60°	0.03	3402-103
VPS-301C	CERAMIC	HRC 60°		3402-104



CERAMIC TYPE VPS-301C



Centering Indicator

- RPM Within 800.
- Use for Internal or External.
- Use for Vertical or Horizontal.
- While Spindle Rotates, With Stop bar for Fixing The Head The centering Indicator Always faces the operator.

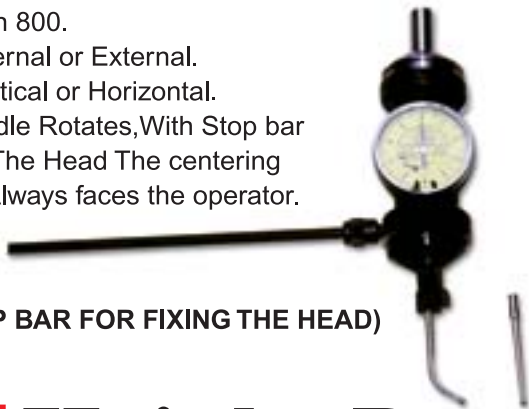

ORDER NO. VCI-170

CODE NO. 3402-130

Shank	10 ^ø	m/m
Length	170	m/m
Internal	4 ^ø ~ 108 ^ø	m/m
External	0 ^ø ~ 108 ^ø	m/m
Min. Indicator	0.01	m/m
Indicator Range	0 ~ 6	m/m
Weight	0.4 kgs	

(WITH STOP BAR FOR FIXING THE HEAD)



Height Presetter

OPTICAL TYPE



HP-50Z BATTERY
LR4476AG13
1SET/2PCS
HP-50ZM
LR44
1SET/2PCS

	STANDARD TYPE	WITH MAGNETIC BASE
ORDER NO.	HP-50Z	HP-50ZM
CODE NO.	3403-001	3403-002

- Height 50mm.
- With magnetic base.
- The red lamp will be lighted up when touched.
- Accuracy 0.005mm
- Combined vertical and horizontal in a unit.
- Weight: 0.7kgs



Height Presetter (For Machining Center)



1. Location the height presetter on a place suitable for a reference surface of work piece.
2. Apply the cutter on the measuring surface and slowly lower the Z-axis. Then, cutter gets near to the measuring position.
3. A distance from the reference surface to the tool tip can be measured easily but precisely, so that this presetter is most suitable not only for machining centers but for NC lathes and NC milling machines.

ORDER NO.	Height from reference surface	WEIGHT	CODE NO.
HP-100	100mm	2.6kgs	3403-010

- * Magnetic base function can be used in vertical position & horizontal position.
- * HEIGHT:100mm±0.005



Z-Zero-Setter



HP-50A



ORDER NO.	H	STYLE	WEIGHT(kg)	CODE NO.
HP-50A	50mm	STANDARD TYPE	1.1	3403-020
HP-50B		WITH MAGNETIC BASE	1.7	3403-021
HP-50AM	50mm	WITH MAGNETIC BASE	1.1	3403-022
HP-50BM		WITH MAGNETIC BASE	1.7	3403-023

1. Have the central measuring portion of the zero setter presetter against a plain surface and aligned if with the outer reference surface. Turn the dial gauge for zero setting.
2. Have the cutter touched against the z zero setter. Once the indicator position at zero the distance between the tool tip to workpiece is 50mm.



HP-50B



Electronic Tool Length Setter

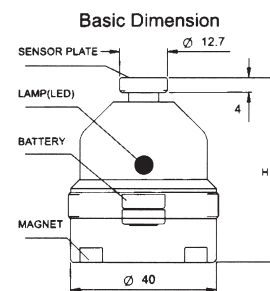

Stainless Steel Base With Magnet

- **HIGH ACCURACY**
- **EASY OPERATION**
- Be sure to remove all chips and all from the sensor plate and the base of the HP-50E as well as from the workpiece and tool.
- To move the tool approaching the sensor plate slowly.
- When touching, the "LED" turns on immediately and "H" is just 50.00 mm.(or2")
- LED will not function if batteries are not set in correctly.
- Designed to be used on ferrous and non-ferrous materials.

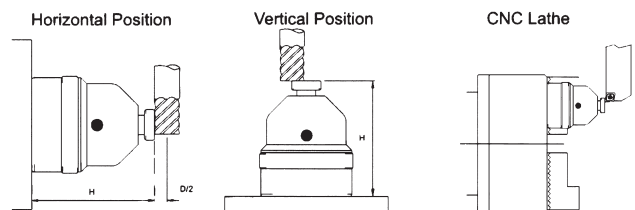

Stainless Steel Base With Magnet

TOOL PRE-SETTER FOR MACHINING CENTERS.
CNC & STANDARD MILLING MACHINES AND
CNC & STANDARD LATHES

ORDER NO.	H	STYLE	WEIGHT(kg)	CODE NO.
HP-50EM	50mm	WITH MAGNETIC BASE	0.2	3403-032
HP-100EM	100mm		1.1	3403-033



Reversible Tapping Attachment for Drilling & Milling Machine

ORDER NO.	TAPPING CAPACITY	SHANK	TO WORK WITH DRILLING MACHINE	WEIGHT	PACKING mm	SPEED	CODE NO.
K1-1/2	Ø3-8mm	1/2"	DRILLING MACHINE MUST EQUIPPED WITH DRILL CHUCK CAPACITY 13MM	0.9KG	90X90X190	1 : 1	3404-001
K1-MT-2	Ø3-8mm	MT-2	DRILLING MACHINE MUST EQUIPPED WITH MT-2 HOLE	1KG	90X90X240	1 : 1	3404-002
K2-1/2	Ø5-10mm	1/2"	DRILLING MACHINE MUST EQUIPPED WITH DRILL CHUCK CAPACITY 13MM	1.6KG	100X100X210	1 : 1	3404-003
K2-MT-2	Ø5-10mm	MT-2	DRILLING MACHINE MUST EQUIPPED WITH MT2 HOLE	1.7KG	100X00X260	1 : 1	3404-004
K3-MT-3	Ø6-14mm	MT-3	OTHERS LIKE MT-3 SHANK BORING HOLE DRILLING MACHINE N.T. AVAILABLE	3.1KG	125X125X300	1 : 1	3404-005
K4-MT-3	Ø12-25mm	MT-3	OTHERS LIKE MT-3 SHANK BORING HOLE DRILLING MACHINE N.T. AVAILABLE	5.5KG	160X160X360	1 : 1	3404-006



K1 TYPE USED CHUCK TO FIX THE TAP
 K2, K3, K4 TYPE USED THE SLIDING PLATE OF THE SQUARE SHARP HOLE TO FIX THE TAP.



Drill Tapper

Including shank, full set of collets, wrench and case.
 (Used for radial drilling, lathe and tapping machines.
 1 Main body, 6 Tap Collet, 1 Drill Chuck Holder
 Optional in Collets & Tapper Sleeves.) 0.6CUFT.



Unit:mm

ORDER NO.	STANDARD ASSEMBLY SPECIFICATION				G.W. kg	MEAS. CFT	CODE NO.
	MAIN BODY 1PC/SET	TAP COLLET 6PCS/SET	TAPER SLEEVE 2PCS/SET	DRILL CHUCK HOLDER 1PC/SET			
VDT-33	MT-3	M8, 10, 12, 14, 16, 18, 20, 22, 24, 27, 30, 33(MM)	33-MT1	33-JT6 With 1/2" Drill Chuck	12.5	0.6	3404-010
	MT-4	1, 1-1/8, 1-1/4(INCH)	33-MT2		13		3404-011
	MT-5	PT1/8, 1/4, 3/8, 1/2 3/4, 1(INCH)	33-MT3		14		3404-012
VDT-24	MT-3	M4, 6, 8, 10, 12, 14, 16, 18, 20, 22, 24, (MM)	24-MT1	24-JT6 With 1/2" Drill Chuck	(W) 12	0.6	3404-013
	MT-4	W3/16, 1/4, 5/16, 3/8, 7/16, 1/2, 5/8, 3/4, 7/8, 1(INCH)	24-MT2		13		3404-014
	MT-5	PT1/8, 1/4, 3/8, 1/2(INCH)	24-MT3				3404-015

Extra Purchase Welcome.



Reversible Tapping Attachments

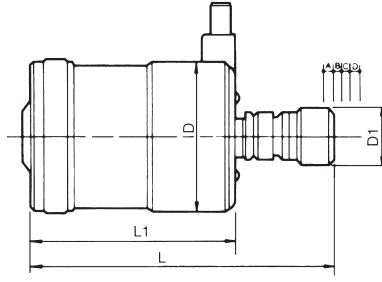

- Radial Float is SELF-CENTERING to compensate for hole center misalignment.
- Unique Double Spring Mechanism produces Automatic Feed and Cushion Drive. There are two springs for the feed and two springs for the reversal. Each set gives you double smoothness for ULTRA accurate tapping applications (not possible with this type of tapping head in the past).
- Pre-set Torque Control Permits easy operation of tap brake torque control
- JACOBS RUBBER FLEX COLLETS are standard accessory.

Reversing Type

ATTACHMENT DESIGNATIONS ORDER NO.	FOR TAPS	SUITABLE ADAPTERS SIZE	REC. MAX SPEED	LENGTH COMPENSATION				D DIA	D1 DIA	L	L1	WEIGHT (kg)	CODE NO.
				R.H. ROTATION COMP A	NON ROTAT EXP. B	LH. ROTAT. EXP. C	LH. ROTAT. EXP. E						
VTA7-JT6	M2-M7	FC-10/FC-11	1500RPM	5	3.5	1.5	7.0	52	23	125.5	94.5	1.2	3404-020
VTA12-JT6	M3-M12	FC-20/FC-21	1000RPM	5	4.5	1.5	8.5	73.5	28	169	122	3	3404-021
VTA20-M20	M8-M20	FC-30/FC-31	600RPM	5.5	5	2.0	9.0	91	38	190	128	5.6	3404-022

Rubber Flex Collet For VTA Tapper

ADAPTER DESIGNATIONS	COLLETS CAPACITY	D4	L	CODE NO.
FC-10	Ø 2.5- Ø 4.5	16	11	3404-030
FC-11	Ø 4.5- Ø 6.5	16	11	3404-031
FC-20	Ø 4.5- Ø 7.5	21.5	13	3404-032
FC-21	Ø 7.5- Ø 10	21.5	13	3404-033
FC-30	Ø 8.0- Ø 16	26.5	15	3404-034
FC-31	Ø 14- Ø 19	26.5	15	3404-035

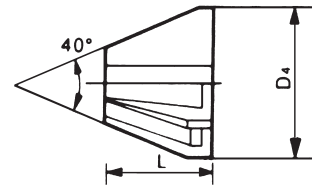

Tap Chuck Series

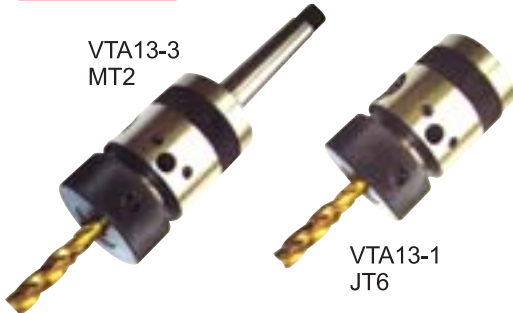

1. THE DESIGN CAN PREVENT THE TAPS CHUCK FROM LOOSENING AFTER TAPPING.
2. SUIT FOR VARIOUS TAPS. LARGE TAPPING CAPACITY. HIGH POWER TORSIONAL.

OPTIONAL:

TAP CHUCK WRENCH



ORDER NO.	CONNECTING TAPER	TAPPING CAPABILITY	CODE NO.
VTA13-1	JT6	Ø2 - 13MM Ø1/8" - Ø1/2"	3404-006
VTA13-2	B16		3404-007
VTA13-3	MT2		3404-008
VTA13-4	MT3		3404-009
VTA16-1	JT3	Ø3 - 16MM Ø1/8" - Ø5/8"	3404-016
VTA16-2	B18		3404-017
VTA16-3	MT2		3404-018
VTA16-4	MT3		3404-019
VTA24-1	MT3	Ø12 - 24MM Ø1/2" - Ø15/16"	3404-023
VTA24-2	MT4		3404-024



Tap Chuck

1. It's suitable for various taps, so it is much more economic and efficient than other brands of taps chuck.
2. The design can prevent the taps chuck from loosening after tapping.

Unit:mm



ORDER NO.	SIZE	TAPPING CAPACITY		Taper Mount NO. DIN or Jacobs	Length (m/m)	Outer Dia. (m/m)	Weight (g)	CODE NO.
		mm	inch					
35000	1/2	M4-M12	1/8-1/2	JT6	75	42	585	3404-056
35002	1/2	M4-M12	1/8-1/2	B16	75	42	585	3404-057
35004	3/8	M4-M12	1/8-1/2	JT2	75	42	590	3404-058
35006	5/8	M9-M18	3/8-3/4	JT6		50		3404-059



Expansible Tapping Holder

1. Floating and expansion design will reduce the differential of motor rotary speed and feed speed so will extend the life of tap.
2. Use ER High Spring Collet, you don't need to worry the few size will delay working, so their value is more than any other tapping system.

STRAIGHT SHANK



3. Strong Vise clamping function which is controlled by one screw will keep the outlet which has been controlled by ER collet, so it can auto-center and you own the double lock and save in clamping.
4. The series can be fitted with ER20 collet as optional accessory.

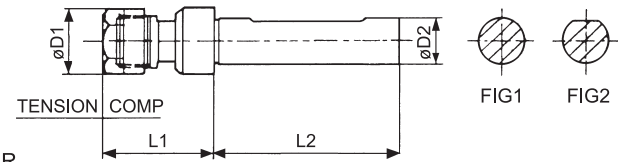

HOLDER

Unit:mm

ORDER NO.	COLLET	HOLDER (D ₂ XL ₂)	FIG	L ₁	D ₁	TAPPING RANGE	WEIGHT KG	CODE NO.
VET-101	ER16	20X80	1	47	28	M3-M10	0.2	3404-040
VET-102	ER16	20X80	2	47	28	(1/8"-3/8")	0.2	3404-041

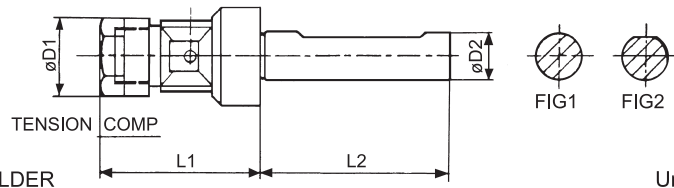

HOLDER

Unit:mm

ORDER NO.	COLLET	HOLDER (D ₂ XL ₂)	FIG	L ₁	D ₁	TAPPING RANGE	WEIGHT KG	CODE NO.
VET-201	ER20	20X80	1	70	34		0.5	3404-042
VET-202	ER20	20X80	2	70	34	M3-M16	0.5	3404-043
VET-251	ER20	25X80	1	70	34	(1/8"-5/8")	0.6	3404-044
VET-252	ER20	25X80	2	70	34		0.6	3404-045

SETS

Unit:mm

ORDER NO.	COLLET	HOLDER (D ₂ XL ₂)	SET/PCS	WEIGHT(kg)	CODE NO.
VET-105	ER16	20X80	8	1	3404-046
VET-106	ER16	20X80	10	1.1	3404-047
VET-253	ER20	20X80	10	1.6	3404-048
VET-254	ER20	20X80	12	1.7	3404-049



Expansible Tapping Holder

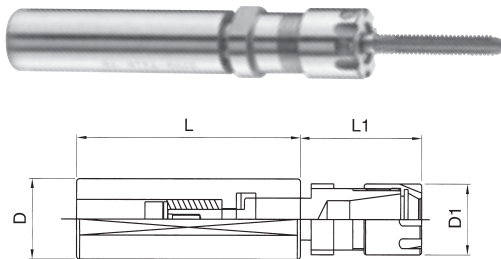

HOLDER

Unit:mm

ORDER NO.	COLLET	HOLDER (DXL)	L ₁	D ₁	TAPPING RANGE	WEIGHT KG	CODE NO.
VET-260	ER16	ER16M 20X70	35	22	M3-M10	0.2	3404-036
VET-261	ER16	ER16M 25X70	35	22	1/8"-3/8"	0.2	3404-037

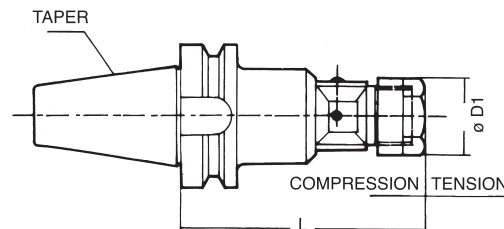

HOLDER

Unit:mm

ORDER NO.	COLLET	HOLDER (DXL)	L ₁	D ₁	TAPPING RANGE	WEIGHT KG	CODE NO.
VET-270	ER32	ER32 32X100	100	50	M3-M25 1/8"-1"	1.5	3404-025
VET-271	ER32	BT40 20X110	110	34	M3-M16	2.2	3404-026
VET-272	ER20	BT50 20X95	95	34	1/8"X5/8"	4	3404-027
VET-273	ER20	BT40 32X110	110	50	M3-M25	2.4	3404-028
VET-274	ER32	BT50 32X110	110	50	1/8"-1"	4.5	3404-029



Quick Change Tapping Chucks

European Type



QUICK CHANGE TAPPING CHUCKS (with length compensation) MAS-BT shank / DIN69871A SK-40, 50

- Tension and compression feature allows taps to follow their own thread lead.
- With extreme light compensation compression and tension operated by ball cage.

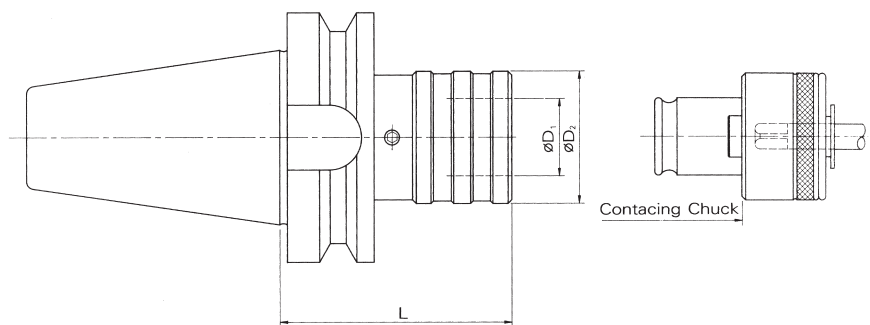

WF-BT40/SK40

ORDER NO.	Thread Size	L	ØD ₂	ØD ₁	Length Compensation		Collets	WEIGHT (g)	CODE NO.
					Compression	Tension			
BT40-WF12	M3-M12	66.5	36	19	7.5	7.5	TC-312	1.3	3404-050
SK40-WF12								1.3	3404-051
BT40-WF20	M8-M20	93.5	53	31	12.5	12.5	TC-820	1.8	3404-052
SK40-WF20								1.8	3403-053
BT40-WF33	M14-M33	162.5	78	48	20	20	TC-1433	4	3404-054
SK40-WF33								4	3404-055

WF-BT50/SK50

ORDER NO.	Thread Size	L	ØD ₂	ØD ₁	Length Compensation		Collets	WEIGHT (kg)	CODE NO.
					Compression	Tension			
BT50-WF12	M3-M12	100	36	19	7.5	7.5	TC-312	4	3404-060
SK50-WF12								4	3404-061
BT50-WF20	M8-M20	101.5	53	31	12.5	12.5	TC-820	4.1	3404-062
SK50-WF20								4.1	3404-063
BT50-WF33	M14-M33	162.3	78	48	20	20	TC-1433	5.8	3404-064
SK50-WF33								5.8	3404-065



Quick Change Tapping Chucks

QUICK CHANGE TAPPING CHUCKS (with length compensation)

MAS-BT shank & DIN 69871A shank

- Tension and compression feature allows taps to follow their own thread lead.

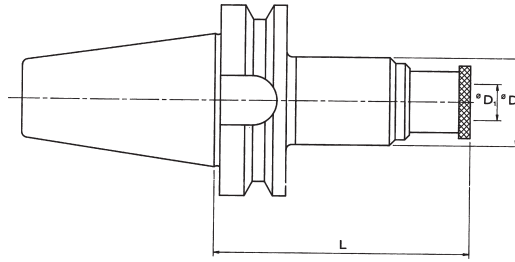

WFE-BT40/SK40

ORDER NO.	Thread Size	L	ØD ₂	ØD ₁	Length Compensation		Collets	CODE NO.	
					Compression	Tension			
BT40-WFE12-135	M3-M12	135	46	19	15	20	TC-312	1.5	3404-070
SK40-WFE12-135		1.5						3404-071	
BT40-WFE12-165		165						3404-072	
SK40-WFE12-165								3404-073	

WFE-BT50/SK50

ORDER NO.	Thread Size	L	ØD ₂	ØD ₁	Length Compensation		Collets	WEIGHT (kg)	CODE NO.
					Compression	Tension			
BT50-WFE12-135	M3-M12	135	46	19	15	20	TC-312	4	3404-080
SK50-WFE12-135		4						3404-081	
BT50-WFE12-165		165						3404-082	
SK50-WFE12-165								3404-083	

QUICK CHANGE TAPPING CHUCKS (with length compensation)

STRAIGHT shank

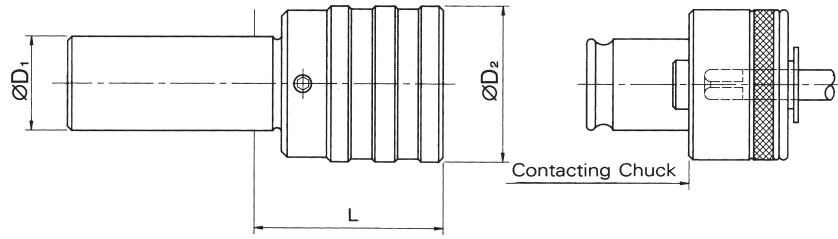

WF-ST

ORDER NO.	Thread Size	ØD ₃	L	ØD ₂	Length Compensation		Collets	HT (kg)	CODE NO.
					Compression	Tension			
ST25-WF20	M8-M20	25	65	53	12.5	1.5	TC-820	1	3404-090
ST32-WF20		32						1	3404-091

QUICK CHANGE TAPPING CHUCKS (type solid)

MAS-BT shank & DIN 69871A shank

- No tension or compensation stroke for use in synchronous tapping (rigid tapping) cycle.

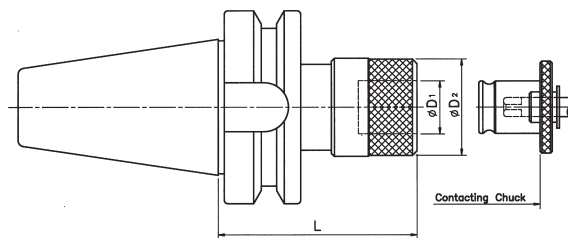

SF-BT40/SK40

ORDER NO.	Thread Size	L	ØD ₂	ØD ₁	Collets)	CODE NO.
BT40-SF12	M3-M12	72	34	19	TC-312B	1	3404-100
SK40-SF12						1	3404-101
BT40-SF20	M8-M20	91	50	31	TC-820B	1.4	3404-102
SK40-SF20						1.4	3404-103
BT40-SF33	M14-M33	130	74	48	TC-1433B	3.5	3404-104
SK40-SF33						3.5	3404-105

SF-BT50/SK50

ORDER NO.	Thread Size	L	ØD ₂	ØD ₁	Collets	GHT (kg)	CODE NO.
BT50-SF12	M3-M12	78	34	19	TC-312B	3.4	3404-110
SK50-SF12						3.4	3404-111
BT50-SF20	M8-M20	95	50	31	TC-820B	3.5	3404-112
SK50-SF20						3.5	3404-113
BT50-SF33	M14-M33	120	76	48	TC-1433B	5.2	3404-114
SK50-SF33						5.2	3404-115



Quick Change Tapping Chucks

QUICK CHANGE TAPPING CHUCKS (type solid)
MORSE TAPER shank

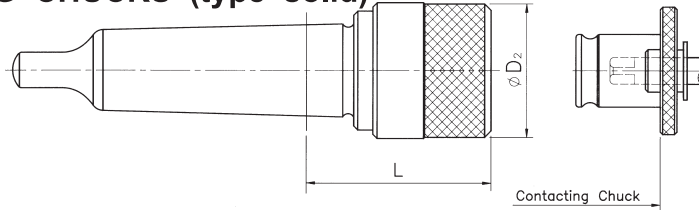

SF-MT

ORDER NO.	Thread Size	L	$\varnothing D_2$	Collets	Weight(kg)	CODE NO.
MT2-SF12	M3-M12	44	32	TC-312B	0.3	3404-120
MT3-SF20	M8-M20	61	50	TC-820B	0.8	3404-121
MT4-SF33	M14-M33	91	72	TC-1433B	2.2	3404-122

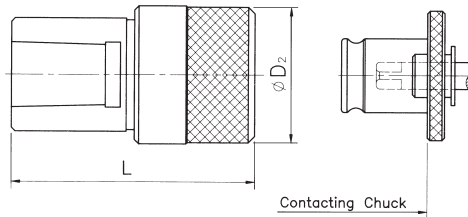

SF-JTA

ORDER NO.	Thread Size	L	$\varnothing D_2$	Collets	Weight(kg)	CODE NO.
JTA6-SF12	M3-M12	65	32	TC-312B	0.3	3404-130
JAT2-SF12	M8-M12	65	32	TC-312B	0.3	3404-131

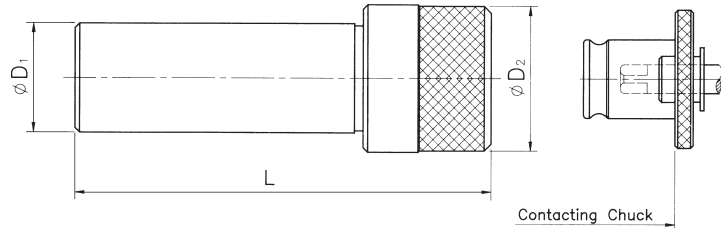

SF-ST

ORDER NO.	Thread Size	L	$\varnothing D_2$	$\varnothing D_1$	Collets	Weight(kg)	CODE NO.
ST20-SF12	M3-M12	100	32	20	TC-312B	0.3	3404-140

QUICK CHANGE TAPPING CHUCKS (type solid + floating)
MORSE TAPER shank

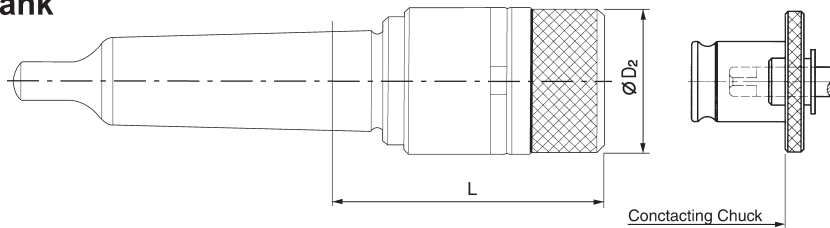

MT-SFP

ORDER NO.	Thread Size	L	$\varnothing D_2$	Floating	Collets	Weight(kg)	CODE NO.
MT2-SFP12	M3-M12	65	32	0.5	TC-312B	0.4	3404-150
MT3-SFP20	M8-M20	91	50	1.0	TC-820B	1.3	3404-151

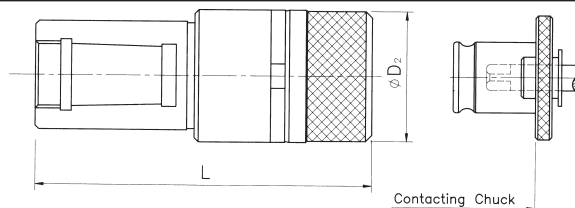

JTA-SFP

ORDER NO.	Thread Size	L	$\varnothing D_2$	Floating	Collets	Weight(kg)	CODE NO.
JTA6-SFP12	M3-M12	100	32	0.5	TC-312B	0.5	3404-160
JTA2-SFP12	M8-M12	100	32	0.5	TC-820B	0.5	3404-161



Quick Change Tapping Chucks

QUICK CHANGE TAP COLLETS (with overload clutch)

1PC≐0.18kg

Size	Thread	Tap Shank		∅D ₁	L ₁	L ₂	ORDER NO.	CODE NO.
		∅D	□					
TC312 (#1)	M3	4	3.2	19	21.5	25	312-01	3404-200
	M4	5	4				312-02	3404-201
	M5	5.5	4.5				312-03	3404-202
	M6	6	4.5				312-04	3404-203
	M7	6.2	5				312-05	3404-204
	M8	6.2	5				312-06	3404-205
	M9	7	5.5				312-07	3404-206
	M10	7	5.5				312-08	3404-207
	M11	8	6				312-09	3404-208
	M12	8.5	6.5				312-10	3404-209
	•M14	10.5	8				•312-11	3404-210
	•M15	10.5	8				•312-12	3404-211
	UNC 1/4	6	4.5				312-13	3404-212
	UNC 5/16	6.1	5				312-14	3404-213
	UNC 3/8	7	5.5				312-15	3404-214
	UNC 7/16	8	6				312-16	3404-215
	UNC 1/2	9	7				312-17	3404-216
	•UNC 9/16	10.5	8				•312-18	3404-217
	PT 1/8	8	6				312-19	3404-218
	PT 1/4	11	9				312-20	3404-219

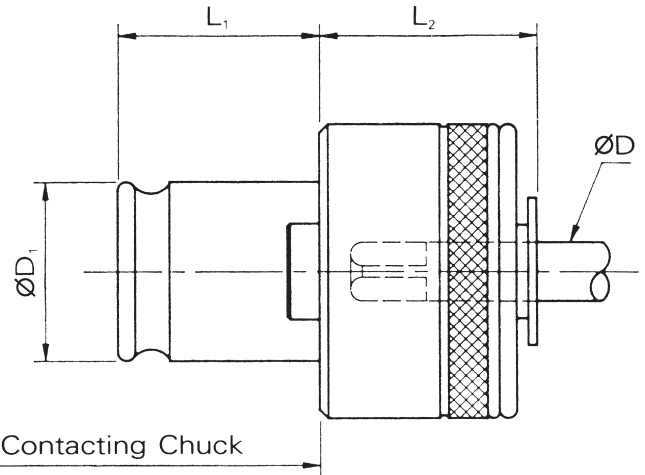

- Torque is factory-set to protect the tap for which a particular collet is designed. Small adjustments can be made by a trained user to accommodate tap strength and material variations.
- Collet stops driving when set torque is exceeded.
- A collet is necessary for each tap shank diameter.
- DIN & ISO systems : please see page 68.

1PC≐1.8kg

1PC≐0.6kg

Size	Thread	Tap Shank		∅D ₁	L ₁	L ₂	ORDER NO.	CODE NO.
		∅D	□					
TC820 (#2)	M7	6.2	5	31	35	34	820-01	3404-230
	M8	6.2	5				820-02	3404-231
	M9	7	5.5				820-03	3404-232
	M10	7	5.5				820-04	3404-233
	M11	8	6				820-05	3404-234
	M12	8.5	6.5				820-06	3404-235
	M14	10.5	8				820-07	3404-236
	M15	10.5	8				820-08	3404-237
	M16	12.5	10				820-09	3404-238
	M17	13	10				820-10	3404-239
	M18	14	11				820-11	3404-240
	M20	15	12				820-12	3404-241
	M22	17	13				820-13	3404-242
	UNC 3/8	7	5.5				820-14	3404-243
	UNC 7/16	8	6				820-15	3404-244
	UNC 1/2	9	7				820-16	3404-245
	UNC 9/16	10.5	8				820-17	3404-246
	UNC 5/8	12	9				820-18	3404-247
	UNC 3/4	14	11				820-19	3404-248
	UNC 7/8	17	13				820-20	3404-249
	PT 1/8	8	6				820-21	3404-250
	PT 1/4	11	9				820-22	3404-251
	PT 3/8	14	11				820-23	3404-252
	PT 1/2	18	14				820-24	3404-253

Size	Thread	Tap Shank		∅D ₁	L ₁	L ₂	ORDER NO.	CODE NO.
		∅D	□					
TC1433 (#3)	M14	10.5	8	48	55.5	45	1433-01	3404-260
	M15	10.5	8				1433-02	3404-261
	M16	12.5	10				1433-03	3404-262
	M17	13	10				1433-04	3404-263
	M18	14	11				1433-05	3404-264
	M20	15	12				1433-06	3404-265
	M22	17	13				1433-07	3404-266
	M24	19	15				1433-08	3404-267
	M25	19	15				1433-09	3404-268
	M26	20	15				1433-10	3404-269
	M27	20	15				1433-11	3404-270
	M28	21	17				1433-12	3404-271
	M30	23	17				1433-13	3404-272
	M32	24	19				1433-14	3404-273
	M33	25	19				1433-15	3404-274
	M34	26	21				1433-16	3404-275
	M35	26	21				1433-17	3404-276
	M36	28	21				1433-18	3404-277
	UNC 9/16	10.5	8				1433-19	3404-278
	UNC 5/8	12	9				1433-20	3404-279
	UNC 3/4	14	11				1433-21	3404-280
	UNC 7/8	17	13				1433-22	3404-281
	UNC 1	20	15				1433-23	3404-282
	UNC 1 1/8	22	17				1433-24	3404-283
	UNC 1 1/4	24	19				1433-25	3404-284
	UNC 1 3/8	26	21				1433-26	3404-285
	PT 1/4	11	9				1433-27	3404-286
	PT 3/8	14	11				1433-28	3404-287
	PT 1/2	18	14				1433-29	3404-288
	PT 3/4	23	17				1433-30	3404-289
	PT 1	26	21				1433-31	3404-290



Quick Change Tapping Chucks

QUICK CHANGE TAP COLLETS
(without overload clutch)

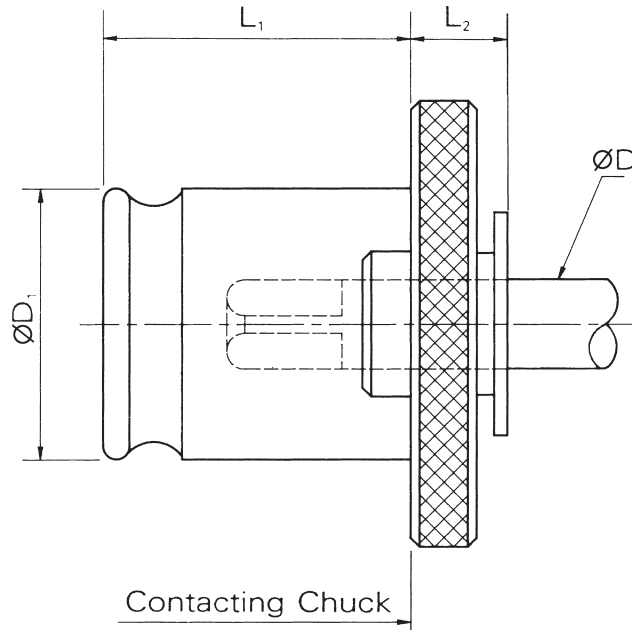

1PC±0.08kg

Size	Thread	Tap Shank		ØD ₁	L ₁	L ₂	ORDER NO.	CODE NO.
		ØD	□					
TC312B (#1)	M3	4	3.2	19	21.5	7	312B-01	3404-300
	M4	5	4				312B-02	3404-301
	M5	5.5	4.5				312B-03	3404-302
	M6	6	4.5				312B-04	3404-303
	UNC5/16	6.1	5				312B-05	3404-304
	M7/M8	6.2	5				312B-06	3404-305
	M9/M10	7	5.5				312B-07	3404-306
	M11	8	6				312B-08	3404-307
	M12	8.5	6.5				312B-09	3404-308
	UNC1/2	9	7				312B-10	3404-309
	M14	10.5	8				312B-11	3404-310
	PT1/4	11	9				312B-12	3404-311

- A collet is necessary for each tap shank diameter.
- DIN & ISO systems : please see page 68.

1PC±0.8kg

1PC±0.28kg

Size	Thread	Tap Shank		ØD ₁	L ₁	L ₂	ORDER NO.	CODE NO.
		ØD	□					
TC820B (#2)	M7/M8	6.2	5	31	35	11	820B-01	3404-330
	M9/M10	7	5.5				820B-02	3404-331
	M11	8	6				820B-03	3404-332
	M12	8.5	6.5				820B-04	3404-333
	UNC1/2	9	7				820B-05	3404-334
	M14	10.5	8				820B-06	3404-335
	PT1/4	11	9				820B-07	3404-336
	UNC5/8	12	9				820B-08	3404-337
	M16	12.5	10				820B-09	3404-338
	M17	13	10				820B-10	3404-339
	M18	14	11				820B-11	3404-340
	M20	15	12				820B-12	3404-341
	M22	17	13				820B-13	3404-342
	PT1/2	18	14				820B-14	3404-343

Size	Thread	Tap Shank		ØD ₁	L ₁	L ₂	ORDER NO.	CODE NO.
		ØD	□					
TC1433B (#3)	M14/M15	10.5	8	48	55.5	14	1433B-01	3404-360
	PT1/4	11	9				1433B-02	3404-361
	UNC5/8	12	9				1433B-03	3404-362
	M16	12.5	10				1433B-04	3404-363
	M17	13	10				1433B-05	3404-364
	M18	14	11				1433B-06	3404-365
	M20	15	12				1433B-07	3404-366
	M22	17	13				1433B-08	3404-367
	PT1/2	18	14				1433B-09	3404-368
	M24/M25	19	15				1433B-10	3404-369
	M26/M27	20	15				1433B-11	3404-370
	M28	21	17				1433B-12	3404-371
	UNC1 1/8	22	17				1433B-13	3404-372
	M30	23	17				1433B-14	3404-373
	M32	24	19				1433B-15	3404-374
	M33	25	19				1433B-16	3404-375
	M34/M35	26	21				1433B-17	3404-376
	M36/M38	28	21				1433B-18	3404-377



Mini Type Arm Type Air Tapping Unit

ACCESSORIES

- Air tapping spindle
- Parallel arm
- Table mounting column
- Air unit
- Choose any six safety clutch tapping adapters
- Radial jib

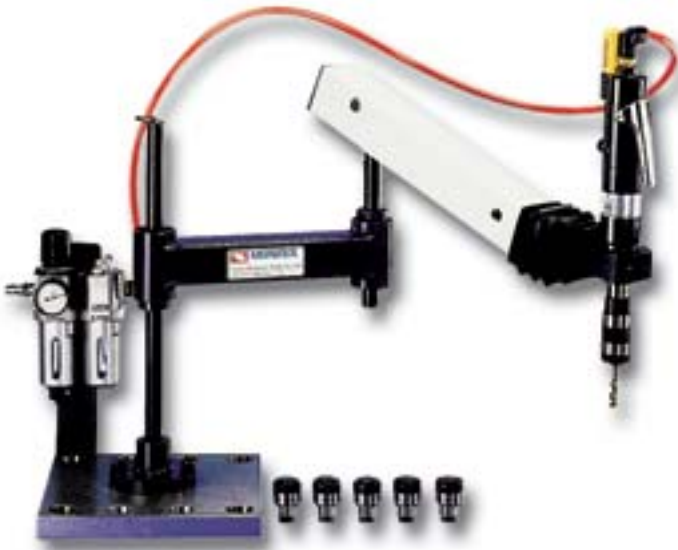

ORDER NO.	VAT-708	VAT-712	VAT-716
For Tap	M2~M8	M3~M12	M3~M16
	TC-312	TC-312	TC-312
Speed (rpm)	700	400	400
Weight (kgs)	12	12	12
Work Range	Rmax 700mm		
Code No.	3404-410	3404-411	3404-412



Small Arm Type Air Tapping Unit

ACCESSORIES

- Air tapping spindle
- Parallel arm
- Table mounting column
- Air unit
- Choose any six safety clutch tapping adapters
- Radial jib, increases arm reach by 500mm

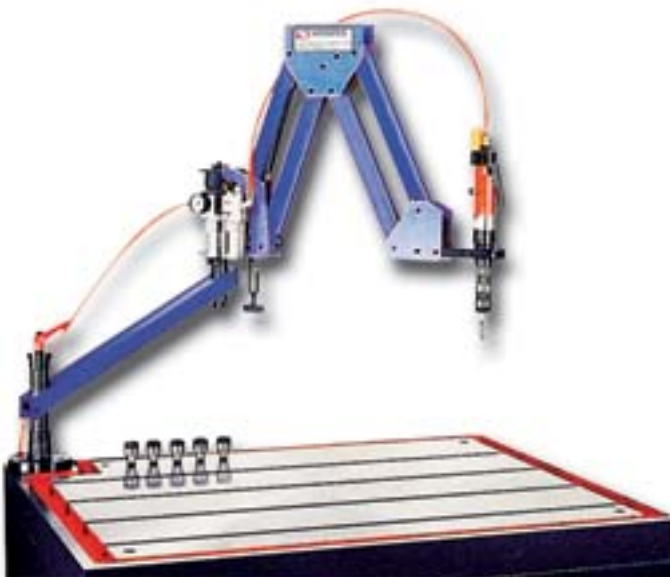

ORDER NO.	VAT-1408	VAT-1412	VAT-1416
For Tap	M2~M8	M3~M12	M3~M16
	TC-312	TC-312	TC-312
Speed (rpm)	700	400	400
Weight (kgs)	18	18	20
Work Range	Rmax 1400mm		
	Rmin 200mm		
Code No.	3404-415	3404-416	3404-417



Arm Type Air Tapping Unit

WORK RANGE 1600X500m/m
RMAX. X MIN.

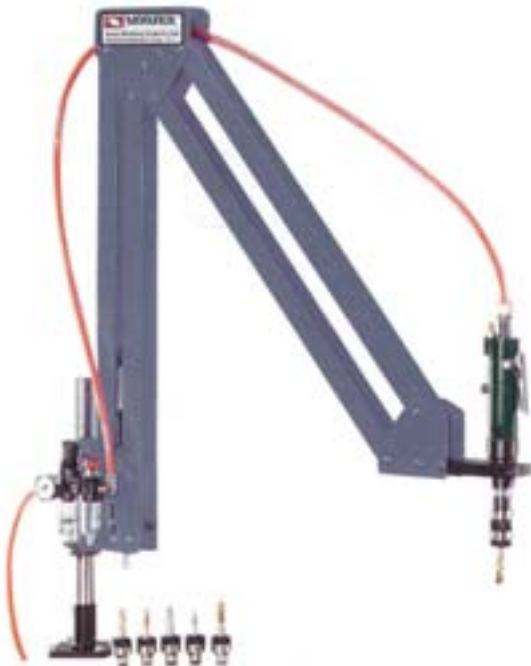

VAT-1608/1612/1616 VAT-1908/1912/1916

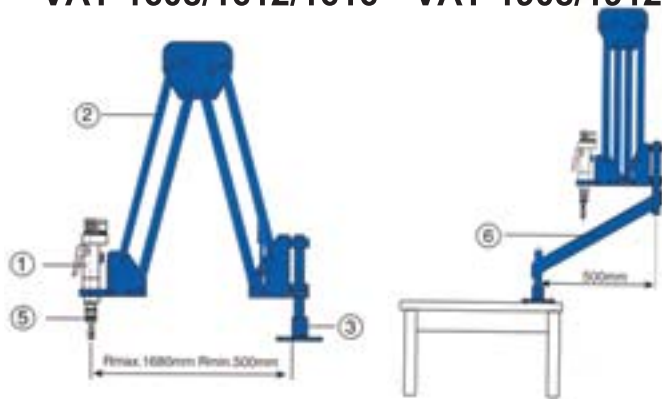

To solve all tapping problems

1. Rapid positioning and high machining speed increase productivity.
2. Lower tap damage rate, high thread accuracy.
3. Tap shall never break for tapping through-hole or blind-hole.
4. Tapping for heavier workpiece requires no positioning equipments nor movement, large work area.
5. Lower machining cost than that by CNC machine, drilling machine or manual tapping operation.
6. Drilling to max: 6mm diameter
7. Easy operation, no experience or strength required.

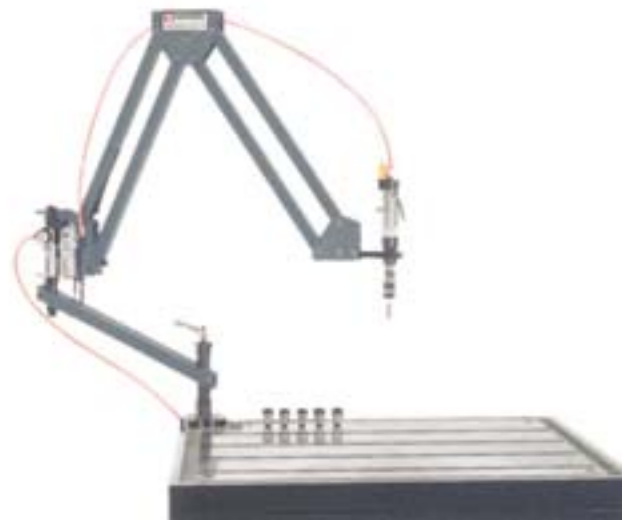

WORK RANGE 1900X200m/m
RMAX. X MIN.

ORDER NO.	VAT-1608	VAT-1612	VAT-1616
For Tap	M2~M8	M3~M12	M3~M16
	TC-312	TC-312	TC-312
Speed (rpm)	700	400	400
Weight (kgs)	18	18	20
Work Range	Rmax 1600mm		
	Rmin 500mm		
Code No.	3404-420	3404-421	3404-422

ORDER NO.	VAT-1908	VAT-1912	VAT-1916
For Tap	M2~M8	M3~M12	M3~M16
	TC-312	TC-312	TC-312
Speed (rpm)	700	400	400
Weight (kgs)	20	18	22
Work Range	Rmax 1900mm		
	Rmin 200mm		
Code No.	3404-425	3404-426	3404-427

VAT-1608, 1612, 1616 STANDARD ACCESSORIES

1. Air tapping spindle
2. Parallel arm
3. Table mounting column
4. Air unit
5. Choose any six safety clutch tapping adapters

VAT-1908, 1912, 1916 STANDARD ACCESSORIES

1. Air tapping spindle
2. Parallel arm
3. Table mounting column
4. Air unit
5. Choose any six safety clutch tapping adapters
6. Radial jib, increases arm reach by 500mm



Air Tapping Machine

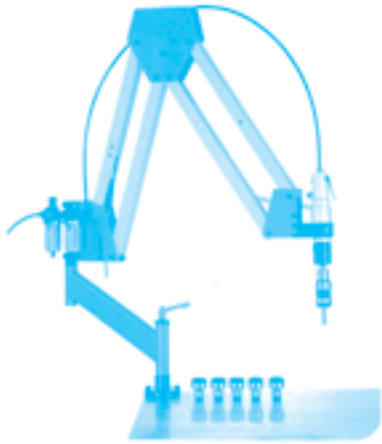

Large Range Type For Tap M4~M20, TC-312B, TC-820B

STANDARD ACCESSORIES:

- Air tapping spindle
- Parallel arm
- Table mounting column
- Air unit
- Choose any six safety clutch tapping adapters
- Radial jib, increases arm reach by 500mm

ORDER NO.		SPEED (rpm)	WORK RANGE	WEIGHT (kg)	CODE NO.
VAT-1920	M4~M20	150/400	Rmax 1900mm	31	3404-430
VAT-1922	M4~M22	120/300	Rmin 200mm		3404-431



Air Hydraulic Special Accessories Of Tapping Machine

90° and Various Degree Tapping Device



ORDER NO.		WEIGHT (kg)	CODE NO.
AT08-90°	VAT-708 VAT-1608 VAT-1408 VAT-1908	1.1	3404-440
AT12-90°	VAT-712 VAT-1612 VAT-1412 VAT-1912	1.1	3404-441

ORDER NO.	FOR PE	WEIGHT (kg)	CODE NO.
AT16-90°	VAT-716 VAT-1616 VAT-1416 VAT-1916	1.5	3404-442
AT20-90°	VAT-1920	1.5	3404-443
AT22-90°	VAT-1922	1.5	3404-444



Magnetic Base For Air Tapping Machine

PORTABLE & MOVEABLE AIR TAPPING ARM

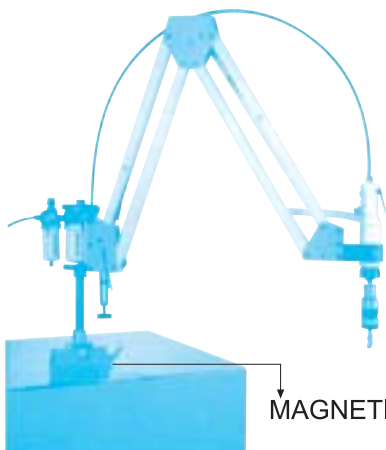

MAGNETIC BASE

ORDER NO.	Magnetic Base		Suit For VAT-Type	WEIGHT (kg)	CODE NO.
	Holding power	Dimension mm			
VLM-300A	300kg	155x90x93	VAT-7□□ VAT-14□□ VAT-16□□	8.6	3404-450
VLM-600A	600kg	224x115x120	VAT-1920 VAT-1922	2.1	3404-451



Specification For Taper Shank

BT Shank (MAS403B)

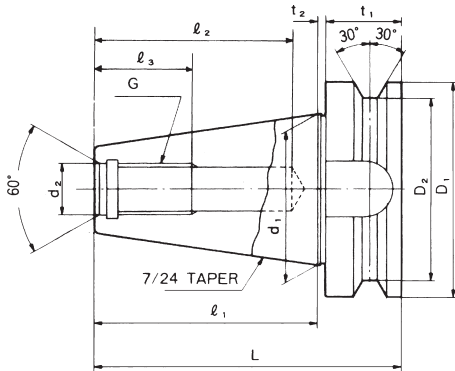

Shank	D ₁	D ₂	t ₁	t ₂	l ₁	l ₂	l ₃	L	d ₁	d ₂	G
BT30	46	38	20	2	48.4	34	24	70.4	31.75	12.5	M12
BT35	53	43	22	2	56.4	34	24	80.4	38.1	12.5	M12
BT35-MS	53	43	20	2	56.5	34	27	78.5	38.1	13	M12
BT40	63	53	25	2	65.4	70	30	92.4	44.45	17	M16
BT45	85	73	30	3	82.8	70	38	115.8	57.15	21	M20
BT50	100	85	35	3	101.8	90	45	139.8	69.85	25	M24

DIN/ISO Shank (DIN 69871 Form A / DIN 7388-1)

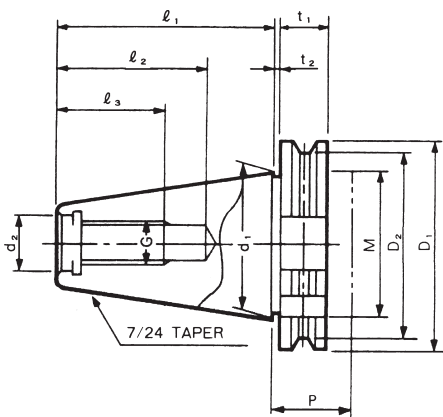

Shank	D ₁	D ₂	t ₁	t ₂	l ₁	l ₂	l ₃	d ₁	d ₂	M	P	G
ISO 40	63.55	56.25			68.4	42.5	32	44.45	17	44.7		M16
ISO 45	82.55	75.25	15.9	3.2	82.7	52.5	40	57.15	21	57.4	35	M20
ISO 50	97.5	91.25			101.75	61.5	47	69.85	25	70.1		M24

Drill Chuck Taper (JACOBS)

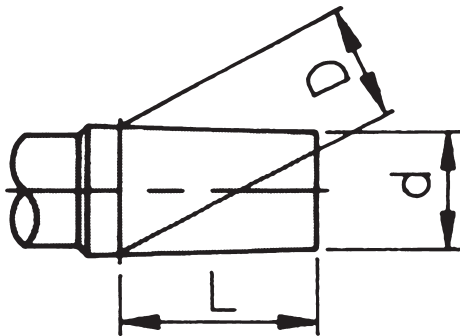

Taper No.	T _{sper}	D	d	L
JT0	0.04929	6.35	5.802	11.112
JT1	0.07709	9.754	8.469	16.669
JT2'short	0.08155	13.940	12.386	19.050
JT2	0.08155	14.199	12.386	22.225
JT33	0.06350	15.850	14.237	25.400
JT6	0.05191	17.170	15.852	25.400
JT3	0.05325	20.599	18.951	30.956
(JT4)	0.05240	28.550	26.346	42.069
(JT5)	0.05183	35.890	33.422	47.625

Drill Chuck Taper (DIN 238)

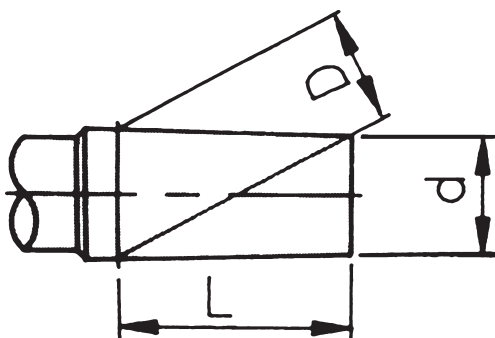

Taper No.	T _{sper}	D	d	L
B 6	0.05	6.350	5.85	10
B10	0.04988	10.094	9.40	14.5
B12	0.04988	12.065	11.10	18.5
B16	0.04995	15.733	14.50	24.0
B18	0.04995	17.780	16.20	32.0
B22	0.05020	21.793	19.80	40.5
B24	0.05020	23.825	21.30	50.5



Deluxe Type Tool Setting Stand

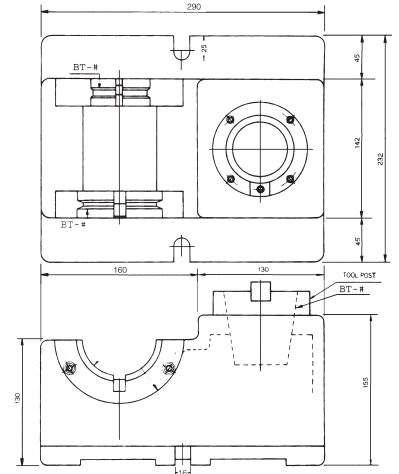

- (A) This tool setting stand is one kind of subsidize tool for helping machine center to work efficiently. To be used fixing the tools on tool holder. It could avoid the method of using draw bar to fix (on machine center). It is both safety and don't effect the precision of machine's spindle.
- (B) It could selet using on horizontal or vertical lines, simple & quick operations.
- (C) A multi-function tool, it is changeable, has two kinds of specifications can be used. That is to say, one machine could be used as two sets machines.
- (D) Additional special accessories to make your operating more convenient.

ORDER NO.	SHANK TAPERS			WEIGHT (kg)	CODE NO.
	TOOL POST	ADAPTER HOLDING			
VTD-1	BT-#40x1	BT-#40x2		25	3405-001
VTD-2	BT-#50x1	BT-#50x2		23	3405-002
VTD-3	BT-#50x1	BT-#50x1	BT-#40x1	24	3405-003
VTD-4	BT-#40x1	BT-#50x1	BT-#40x1	24	3405-004



Simple Type Tool Setting Stand



- A. This tool setting stand is one kind of subsidize tool for helping machine center to work efficiently. To be used fixing the tools on tool holder. It could avoid the method of using draw bar to fix (on machine center). It is both safety and don't effect the precision of machine's spindle.
- B. It is simple structive type. And could fix tooling on the above and hold the pull studs on the below of it. This is the excellent helping tools for simple, rapid and safety.

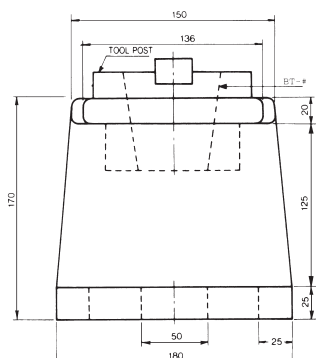

ORDER NO.	SHANK TAPERS	STD	WEIGHT	CODE NO.
VTS-BT-30	30	BT	13kg	3405-010
VTS-BT-40	40	ISO	13kg	3405-011
VTS-BT-50	50	NT	12kg	3405-012
VTS-SK-30	30	DIN 69871A	13kg	3405-013
VTS-SK-40	40		13kg	3405-014
VTS-SK-50	50		12kg	3405-015

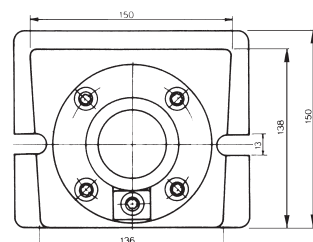



Tool Holder Locking Device

ORDER NO.	STD	WEIGHT (kg)	CODE NO.
VTG-BT30	ISO NT (SAME TAPER) BT	3.7	3405-020
VTG-BT40		3.7	3405-021
VTG-BT50		10.4	3405-022
VTG-SK30	DIN69871A	3.7	3405-023
VTG-SK40		3.7	3405-024
VTG-SK50		10.4	3405-025



Tool Holder Locking Device

TILTING TYPE

ORDER NO.	STD	WEIGHT (kg)	CODE NO.
VTL-BT30	ISO NT BT	4	3405-030
VTL-BT40		4	3405-031
VTL-BT50		8	3405-032
VTL-SK30	DIN69871A	4	3405-033
VTL-SK40		4	3405-034
VTL-SK50		8	3405-035



Tool Holder Locking Fixtures

ORDER NO.	STD	WEIGHT (kg)	CODE NO.
VTF-BT30	ISO BT	12	3405-040
VTF-BT40		12	3405-041
VTF-BT50		14	3405-042
VTF-SK30	DIN69871A	12	3405-043
VTF-SK40		12	3405-044
VTF-SK50		14	3405-045



Tilting Tool Locking Device

ORDER NO.	STD	WEIGHT (kg)	CODE NO.
VTU-BT30	ISO NT BT	11.3	3405-026
VTU-BT40		11.3	3405-027
VTU-BT50		15	3405-028
VTU-SK30	DIN69871A	11.3	3405-036
VTU-SK40		11.3	3405-037
VTU-SK50		15	3405-038





End Mill Sheath Rack



Material:ABS
with 62 sheaths.

unit:mm

ORDER NO.	CAPACITY RANGE	SIZE	WEIGHT(kg)	CODE NO.
VMS-2	Ø6~Ø42	205x205x80	0.4	3405-050



Spindle Taper Wiper



- Easily and quickly for cleaning single hole.
- Plastic body, the taper wiper is made of special cotton material, will not be damage to spindle.
- The BT & DIN of taper are same

ORDER NO.	TAPER NO.	TOTAL LENGTH	WEIGHT(kg)	CODE NO.
VTW-30	#30	168mm	0.05	3405-060
VTW-40	#40	185mm	0.06	3405-061
VTW-50	#50	235mm	0.13	3405-062



Spindle Taper Wiper



ORDER NO.	TAPER NO.	TOTAL LENGTH	WEIGHT	CODE NO.
VTW-63A	HSK63A	166mm	0.08kg	3405-120
VTW-50H	HSK50A	159mm	0.08kg	3405-121
VTW-63H	HSK63H	167mm	0.0.8kg	3405-122



Tooling Trolleys

ORDER NO.:VTT-2
WEIGHT:38kg

ORDER NO.:VTT-6

ORDER NO.:VTT-5
WITH 2 DRAWERS

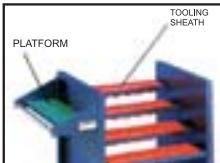

WEIGHT:65kg

ORDER NO.	STD	CODE NO.
VTT-2-30	BT-30 DIN 69871A	3405-100
VTT-2-40	BT-40 DIN 69871A	3405-101
VTT-2-50	BT-50 DIN 69871A	3405-102

ORDER NO.	TOOLING SHEATH CAPACITY			SIZE (mm)
	BT-30	BT-40	BT-50	
VTT-2	32 PCS/SET	28 PCS/SET	20 PCS/SET	960(L) 950(W) 840(H)

ORDER NO.	STD	CODE NO.
VTT-6-30	BT-30 DIN 69871A	3405-105
VTT-6-40	BT-40 DIN 69871A	3405-106
VTT-6-50	BT-50 DIN 69871A	3405-107

ORDER NO.	STD	CODE NO.
VTT-5-30	BT-30 DIN 69871A	3405-110
VTT-5-40	BT-40 DIN 69871A	3405-111
VTT-5-50	BT-50 DIN 69871A	3405-112



Tooling Sheath Rack



THE BT & DIN OF TAPER ARE SAME.

ORDER NO.	WEIGHT(kg)	CODE NO.	SIZE
VTTR-BT-30	2.64	3405-120	595mm(L)
VTTR-BT-40	2.64	3405-121	143mm(W)
VTTR-BT-50	2.64	3405-122	225mm(H)



Tooling Sheath



THE BT & DIN OF TAPER ARE SAME.

ORDER NO.: VTTS-BT-30
WEIGHT:0.077kg
CODE NO. 3405-130
SIZE: 48 X 138 X 65mm

ORDER NO.: VTTS-BT-40
WEIGHT:0.085kg
CODE NO. 3405-131
SIZE: 63 X 138X 74mm

ORDER NO.: VTTS-BT-50
WEIGHT:0.123kg
CODE NO. 3405-132
SIZE: 93 X 138X 104mm



Tool Presetter

TP-3040E ECONOMICAL-TYPE TOOL PRESETTER ORDER NO. TP-3040E CODE NO.3405-400

- Z axis is provided the Square Carriage and treated by special scratch.
- The base of X axis is provided the Dove Tail Slot which is grind and treated by special scratch to ensure the durability of parallelism.
- Spindle sizes can be changed by using different sleeves(BT#50,#40, #30) to inspect different sizes of tools. The tool presetter of standard sleeve is BT-50
- The optional sleeve is O.D. BT-50 XI D. BT-40 and O.D. BT-50X I.D. BT-30
- Digimatic Readout is provided to display the measuring size.

STANDARD ACCESSORIES

Digimatic Readout (XxZ:200x450m/m)
Test Arbor BT#50(DxL:50x250mm)
Dial Gauge (2 sets) 0.01mm
Protective Dust-Resistance Plastic Cover

OPTIONAL ACCESSORIES

1.SLEEVE



ORDER NO.	SIZE	CODE NO.
S50-40	BT-50XBT-40	3405-410
S50-30	BT-50XBT-30	3405-411

2.TEST ARBOR



ORDER NO.	SIZE	CODE NO.
A50	BT-50	3405-412
A40	BT-40	3405-413
A30	BT-30	3405-414



SPECIFICATIONS

Range of measurement	D:300mm, L:400 mm
Graduation	Xaxis:0.01 mm
	Zaxis: 0.01 mm
Machine size(LxWxH)	662x222x862 mm
G.W	135kgs



Tool Presetter

TP-3040 DELUXE-TYPE TOOL PRESETTER ORDER NO. TP-3040 CODE NO.3405-401

- The Z spindle use Swiss made non-pitch screw pole. Can quick move and minor adjustment. Movement slightly and swiftly.
- The special equipment "Lock Up Setting" is installed around the spindle to reduce the aberration when measuring.
- Spindle sizes can be changed by using different sleeves to inspect different sizes of tools..
- The standard of sleeve is BT-50, the optional is O.D. BT-50 XI.D. BT-40, O.D. BT-50 X I.D. BT-30
- Germany Digimatic Readout is provided on X axis to display the measuring number.
- Ball Screw bearing Unit is provided on X axis to increase the accuracy.
- Tapered Bearing Units is provided on Z axis for making movement more smoothly.
- Precision Linear Guide is provided on Z axis for wear-resistance and long-term accuracy.

STANDARD ACCESSORIES

Digimatic Readout (XxZ:200x450m/m)
Test Arbor BT#50(DxL:50x250mm)
Dial Gauge (2 sets) 0.01mm
Cabinet
Dust-Resistance Plastic Cover

SPECIFICATIONS

Range of measurement	D:300mm,L:400mm
Graduation	Xaxis:0.01mm
	Zaxis:0.01mm
Size(LxWxH)	
Machine	662x222x860mm
Cabinet	650x500x760mm
Weight	
Machine	110kgs
G.W	135kgs





Tool Presetter

TP-3040Q OPTICAL TYPE TOOL PRESETTER ORDER NO. TP-3040Q CODE NO.3405-402

- The special equipment "Lock Up Setting" is installed around the spindle to reduce the aberration when measuring.
- Spindle sizes can be changed by using different sleeves to inspect different sizes of tools.
- The standard of sleeve is BT-50, the optional is O.D. BT-50 X I.D. BT-40, O.D. BT-50 X I.D. BT-30.
- Digital Readout is provided on X and Z axis to display the measuring number.
- Ball Screw Bearing Unit is provided on X axis to increase the accuracy.
- Tapered Bearing Units is provided on Z axis for making movement more smoothly.
- Precision Linear Guide is provided on Z axis for wear-resistance and long-term accuracy.
- Two sets of Manual Rotary Equipment are attached on the machine.
- Different multiple of Projectors are available.



SPECIFICATIONS

Range of measurement	D:300mm,L:400mm
Graduation	Xaxis:0.005mm Zaxis:0.005mm
Size(LxWxH)	
Machine	662x222x900mm
Cabinet	650x500x760mm
Weight	
Machine	110kgs
Cabinet	57kgs

STANDARD ACCESSORIES

Digital Readout (XxZ:120x420m/m)
Protective (10X)
Test Arbor BT#50(DxL:50x250mm)
Dial Gauge (2 sets) 0,01mm
Cabinet
Dust-Resistance Plastic Cover
Projector 10X



Tool Presetter

TP-3040P DIGITAL READOUT TYPE TOOL PRESETTER



IT CAN BE CONNECT WITH RS 232C

ORDER NO. TP-3040P CODE NO.3405-403

- The special equipment "Lock Up Setting" is installed around the spindle to reduce the aberration when measuring.
- Spindle sizes can be changed by using different sleeves to inspect different sizes of tools.
- Germany Digital Readout is provided on X and Z axis to display the measuring number.
- Ball Screw Bearing Unit is provided on X axis to increase the accuracy.
- Tapered Bearing Units is provided on Z axis for making movement more smoothly.
- Precision Linear Guide is provided on Z axis for wear-resistance and long-term accuracy.

SPECIFICATIONS

Range of measurement	D:300mm,L:400mm
Graduation	Xaxis:0.005mm Zaxis:0.005mm
Size(LxWxH)	
Machine	662x222x900mm
Cabinet	650x500x760mm
Weight	
Machine	110kgs
Cabinet	57kgs

STANDARD ACCESSORIES

Digital Readout (XxZ:170x420m/m)
Test Arbor BT#50(DxL:50x250mm)
Dial Gauge (2 sets) 0.01mm
Cabinet
Dust-Resistance Plastic Cover



Tool Cabinet

ALL THE OVERALL SIZE IS WITHOUT WHEEL HEIGHT.

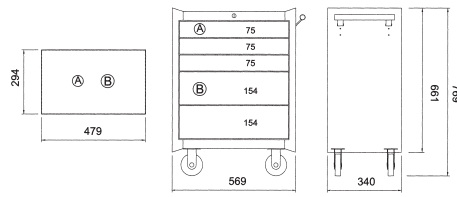

5 Drawers Roll Cabinet
Cuft: 6.9'
Net Weight: 31.3 kgs
Gross Weight: 34 kgs

ORDER NO.	CODE NO.
VTC-S23	3405-144

500WX345DX650Hmm

	mm		
	W	D	H
DRAWERS	480	292	65
DRAWERS	480	292	140

- Ball bearing slide with Quick Disconnect
- Heavy Duty 4"x1" Caster
- Double wall construction
- Electro - Powder Coating to Resist Scratch & solvent markings
- 10mm Top Mat
- All drawers appended to Drawer Liners

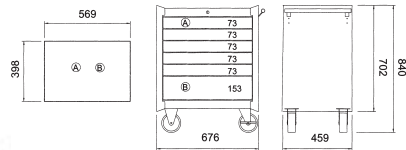

6 Drawers Roll Cabinet
Cuft: 11'
Net Weight: 53.3 kgs
Gross Weight: 55.7 kgs

ORDER NO.	CODE NO.
VTC-MD15	3405-146

680WX460DX675Hmm

	mm		
	W	D	H
DRAWERS	560	412	60
DRAWERS	560	412	140

- Ball bearing slide with Quick Disconnect
- Heavy Duty 5"x2" Caster
- Double wall construction
- Electro - Powder Coating to Resist Scratch & solvent markings
- 10mm Top Mat
- All drawers appended to Drawer Liners

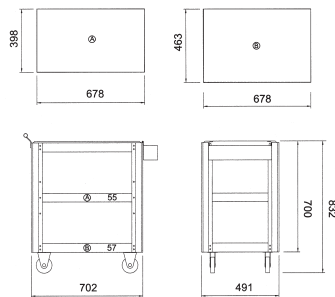

ORDER NO.	CODE NO.
VTC-MR3S	3405-147

700WX490DX700Hmm

Heavy Duty 3 Tray Service Cart
Cuft: 3'
Net Weight: 19.1 kgs
Gross Weight: 21.3 kgs

- Sturdy construction for heavy duty applications
- Standard Duty 3"x1" Caster
- Electro - Powder Coating to Resist Scratch & solvent markings
- Knocked Down Design. Easy to Ship

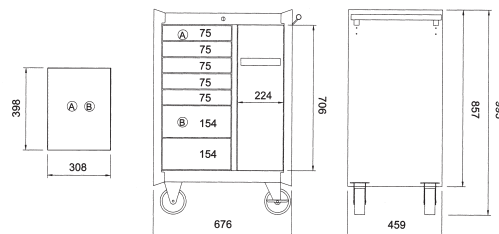

8 Drawers Roll Cabinet
Cuft: 13'
Net Weight: 67.9 kgs
Gross Weight: 72.1 kgs

ORDER NO.	CODE NO.
VTC-LHP25	3405-149

680WX460DX830Hmm

	mm		
	W	D	H
DRAWERS	310	395	60
DRAWERS	310	395	140

- Ergonomic Large Drawer Design
- Ball bearing slide with Quick Disconnect
- Heavy Duty 5"x2" Caster
- Double wall construction
- Electro - Powder Coating to Resist Scratch & solvent markings
- 10mm Top Mat
- All drawers appended to Drawer Liners



Workbench & Workstation

• Strong structure, heavy duty, workbench.

• Workbench with 3 Drawer chest (Ball Bearing Slide)

• Workbench W.Backpanel with 3 Drawer chest (Ball Bearing slide)



ORDER NO.VWB-59B CODE NO.3405-150
SIZE : 1500W x 700D x 800H mm

DESCRIPTION	W	D	H	N.W	G.W.	CUFT
Overall	1500	700	800	60 kgs	64 kgs	7.13
3 Drawer chest	660	305	250			
2 Drawers	572	270	41			
1 Drawer	572	270	65			

ORDER NO.VWB-590 CODE NO.3405-151
SIZE : 1500W x 700D x 1500H mm

DESCRIPTION	W	D	H	N.W	G.W.	CUFT
Overall	1500	700	1500	71 kgs	74.5 kgs	7.74
3 Drawer chest	660	305	250			
2 Drawers	572	270	41			
1 Drawer	572	270	65			
Wall cabinet	420	200	380			



Tool Cabinet



ORDER NO.	CODE NO.
VTB-31	3405-160

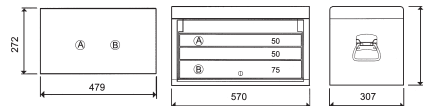

VTB-31: 3 Drawer Top Chest with Drop Front Door
Cuft: 4.05'

Net Weight: 18.4 / 17.1 kgs

Gross Weight: 19.8 / 18.5 kgs

- Double wall construction
- Firm Drop Front Door Prevents Stealing
- Ball bearing slide with Quick Disconnect
- Heavy Duty metal side handle
- All drawers appended to Drawer Liners
- Electro - Powder Coating to Resist Scratch & solvent markings



ORDER NO.	CODE NO.
VTB-41	3405-161

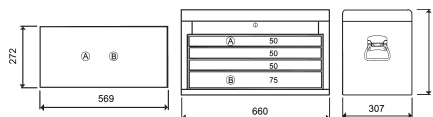

VTB-41: 4 Drawer Top Chest with Drop Front Door
Cuft: 4.5'

Net Weight: 24 / 22.8 kgs

Gross Weight: 24.6 / 23.4 kgs

- Electro - Powder Coating to Resist Scratch & solvent markings
- Double wall construction
- Ball bearing slide with Quick Disconnect
- Heavy Duty metal side handle
- All drawers appended to Drawer Liners



ORDER NO.	CODE NO.
VTB-501	3405-162

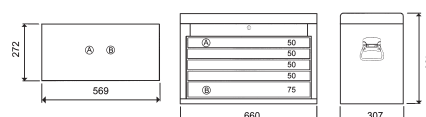

5 Drawer Top Chest

Cuft: 5.2'

Net Weight: 26.3 kgs

Gross Weight: 28.8 kgs

- Ball bearing slide with Quick Disconnect
- Double wall construction
- Heavy Duty metal side handle
- All drawers appended to Drawer Liners
- Electro - Powder Coating to Resist Scratch & solvent markings



Parts Cabinet

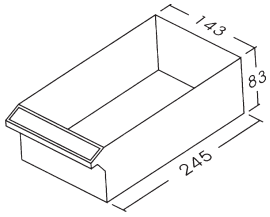

THE SIZE OF DRAWER
245D x 143W x 83H (m/m)

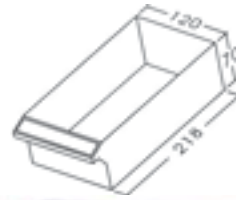

THE SIZE OF DRAWER
218D x 170W x 70H (m/m)



ORDER NO. VA6-212H

ORDER NO. VA6-330H

ORDER NO. VA7-324P

ORDER NO. VA7-448P

ORDER NO.	SIZE (m/m)	METAL	DRAWER NUMBERS	WEIGHT(kg)	CODE NO.
	W x D x H				
VA6-212H	357 x 265 x 569	STEEL PLATE COVER WITH ZINC. Drawer metal: GPS	12PCS	13.22	3405-200
VA6-330H	541 x 265 x 937		30PCS	28.02	3405-201
VA7-324P	440 x 222 x 650		24PCS	16.75	3405-202
VA7-448P	575 x 222 x 937		48PCS	29.39	3405-203



Tool Box



ORDER NO. VTB-102



ORDER NO. VTB-901



ORDER NO. VTB-203



ORDER NO.	SIZE (m/m)	MATERIAL	WEIGHT(kg)	CODE NO.
	W x D x H			
VTB-102	420 x 235 x 180	ABS	1.83	3405-300
VTB-901	378 x 182 x 144		0.895	3405-301
VTB-203	400 x 185 x 180		1.179	3405-302